

Rittal – The System.

Faster – better – everywhere.

IT cooling

ENCLOSURES

POWER DISTRIBUTION

CLIMATE CONTROL

IT INFRASTRUCTURE

SOFTWARE & SERVICES



FRIEDHELM LOH GROUP

What is the best cooling solution?

Climate control concepts from Rittal cover the full spectrum of applications, from cooling a single rack through to entire data centres. Security plus optimum energy and cost efficiency are paramount. A diverse range of technical solutions creates individual climate control concepts for racks, suites and rooms.



- 1 Chillers for IT cooling
- 2 Adiabatic cooling
- 3 Aisle containment
- 4 HPC cooling
- 5 Climate control in the data centre
- 6 Refrigeration container
- 7 Office environments
- 8 Corridor distributors
- 9 Production – IT racks with protection category
- 10 Planning and project management

Further details may be found on the following pages.

ENCLOSURES

POWER DISTRIBUTION

CLIMATE CONTROL

What is the best cooling solution?

from page 2

The diversity of Rittal solutions..... 4

References

from page 6

Liquid Cooling Package DX 6

Liquid Cooling Package CW 10

Liquid Cooling Unit DX 14

IT cooling – Rittal solutions

from page 18

Overview of rack/bayed suite cooling 20

Liquid Cooling Unit DX 22

Liquid Cooling Package DX 28

Liquid Cooling Package CW 34

IT cooling accessories 40

Roof-mounted cooling units 47

Aisle containment 48

Small cooling units 50

CRAC – Computer Room Air Conditioner 54

Chillers for IT cooling 56

10

9

5

IT INFRASTRUCTURE

SOFTWARE & SERVICES



The diversity of Rittal solutions



1 Chiller for IT cooling

Supplies rack, suite and room climate control solutions with cooling medium at a predefined temperature via the integral pump and cooling circuit. A water/glycol mixture is generally used as the cooling medium, because the chiller is sited outdoors, where it emits the absorbed waste heat from the medium to the ambient air. Rittal IT chillers are available in the cooling output range from 15 to 481 kW. Use of an additional free cooler (indirect) saves operating costs at lower temperatures, because there is no need for a chiller compressor mode; only the pump and the free cooler fan are operational.

See page 56



2 Adiabatic dry cooling

Adiabatic dry coolers are used for applications where it is necessary to cool the cooling medium in the data centre (e.g. water) to an outlet temperature that is below the external temperature. Up to the relevant external temperature, the unit functions as a dry cooler. If the external temperature rises above a defined limit, atomised water is sprayed into the air inlet via spray nozzles. This adiabatically lowers the intake temperature.

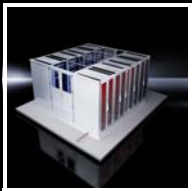

3 Aisle containment

Whether with or without raised floor, cold or hot aisle, aisle containment is a simple technique for decisively improving the efficiency of cooling. Aisle containment prevents mixed air temperatures from forming, which would reduce the drive energy of the fans integrated into the cooling units to the minimum volumetric flow, for optimised efficiency. Rittal cooling solutions are perfectly tailored to this application.

See page 49



4 HPC cooling

With HPC (high-performance computing) applications, enclosures with up to 55 kW thermal load may be cooled with direct rack cooling. With this solution, the HPC enclosure is assigned directly to a water-cooled LCP. An integral intelligent controller allows the LCP to permanently adjust the water flow rate and the volumetric air flow to the required output. The LCP modulates the cooling output precisely to the thermal load of the HPC rack.

See page 34



5 Climate control in the data centre

With CRAC systems, as well as dissipating the thermal output of the IT equipment from the data centre, it is also possible to regulate the humidity inside the data centre. In circulating mode, the CRAC systems cool, heat, filter, humidify and dehumidify the air in the data centre. The raised floor serves as an air intake channel, whereby the cold air is homogeneously distributed throughout the raised floor, and streams upwards in front of the IT enclosures. This allows the heat load to be dissipated. The CRAC systems can condition the humidity to ensure compliance of the air quality with ASHRAE TC 9.9 at all times.

See page 54

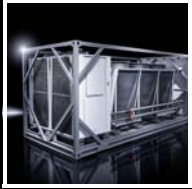

6 Refrigeration container

For simplified transportation and easier siting outdoors, the efficient chiller systems may also be pre-installed in an (ISO) container frame. These cooling centres can be sited in next to no time, and ensure a reliable supply of cooling output for a data centre. Alternatively, two high-efficiency, regulated cooling stations with 70 kW or 100 kW, comprised of two chillers, a free cooler and the hydraulic peripheral, may be used in a container frame to achieve a very low PUE and significant power savings.



7 Office environments

There are a wide range of passive and noise-reduced solutions designed specifically for office environments, where IT enclosures are accommodated in the immediate vicinity of screens and workstations – from enclosure accessories that support cooling with thermal circulation, through to office fans that flood the enclosure with air at reduced noise generation levels.

See page 50



8 Corridor distributors

Rittal offers a wide range of solutions to protect the IT equipment from overheating, specifically for the rising thermal loads in corridor distributors. The thermal load is dissipated in a modulating fashion, based on rack cooling. Depending on the application, redundant solutions may also be used here which permit alternating operation with maximum efficiency. The refrigerant-based split cooling units LCU DX and LCP DX have become well-established for these types of applications.

See page 24



9 Production – IT racks with protection category

There are cooling units designed especially for IT enclosures with a protection category, which reliably cool the enclosure, dissipate the thermal load, and create a system limit guarantee of the protection category.

See page 47



10 Planning and project management

The best product is only as good as the complete system. Professional support with planning and project management therefore provides the basis for fault-free IT operation. Rittal develops and optimises individual ITC solutions on your behalf, from small IT units through to complex data centres.

Our specialists carefully analyse the current status and your future requirements, the structural and physical conditions, and the existing IT structures, and use this information to tap into proven optimisation potential.

IT infrastructure from a single source



“We opted for Rittal because they offer a complete product range and have a good reputation when it comes to data centre and industrial applications.”

Joan Puigdemont
CIO, Noel Alimentaria S.A.U.

ENCLOSURES

POWER DISTRIBUTION

CLIMATE CONTROL

Established in 1940, Noel Alimentaria has become one of the leading companies in the Spanish meat industry. Environmental responsibility is very important to the company. To lower energy consumption, it decided to install a new data centre from Rittal.

New data centre to reduce energy consumption

Most business processes at Noel need the data centre running smoothly. An unscheduled break of just one hour could result in the company losing around € 30,000. Moreover, the company wanted to reduce its energy consumption. Noel estimates that achieving a PUE (Power Usage Effectiveness) value of 1.4 or less could lead to annual savings of € 10,000. Following an exacting selection process, Noel Alimentaria chose the Rittal IT partner Abast for the data centre project.

Focus on secure solutions

Abast equipped the new data centre entirely with Rittal components. These are housed in a Rittal security room. A modular UPS provides an autonomous power supply for 120 minutes. Rittal LCP DX split systems located between the server racks are used to cool the systems. The cold-aisle design principle ensures a high level of energy efficiency. The Rittal CMC monitoring solution keeps track of ambient conditions such as moisture and temperature.

A PUE of around 1.1

Noel Alimentaria uses the Rittal components to run a tier-2 data centre. The IT systems have exhibited 100 percent availability since implementation. The average PUE value achieved is 1.1. This way, Noel has been able to reduce its CO₂ emissions and save an annual € 17,000 in electricity charges.





Edge Data Center with high cooling output ensures maximum computing power with short latency periods

The digital transformation means a radical shake-up for many sectors of industry. In the Industry 4.0 era, new technologies such as smart cities, connected cars, streaming services and mobile data naturally offer new opportunities, but also necessitate the retention and rapid processing of huge data volumes, and linked to this, reliable, efficient server cooling.

You need increasingly flexible and modular IT solutions to achieve this efficiently, quickly and reliably. Ideally, these should be located where the data is produced, i.e. close to your production operations. This is where Edge Data Centers, with their optimised climate control, come into their own, combining short latency times with exceptional computing power and maximum reliability.

The Rittal Edge Data Center is a platform for rapid configuration of a solution that can be used flexibly in any IT environment. The platform, comprised of Rittal TS IT racks, is fully equipped right down to the server architecture and can be efficiently cooled with a Liquid

Cooling Package DX in a range of output categories. In this way, a fully functioning data centre with optimum operating efficiency is available in next to no time.

Rittal Edge Data Center solutions are available with 2, 4, 6 or 8 racks, incorporating predefined components for energy supply, cooling, IT security and monitoring. You have the option of installing the racks as free standing racks, in an IT security room or a container, thus giving you a high degree of flexibility when selecting a location.

Split units tailored to the rack load are used for cooling. Either the Liquid Cooling Unit DX or Liquid Cooling Package is used, depend-

ing on the level of heat loss. The smart CMC III monitoring system keeps a close eye on all relevant parameters. Despite the larger range of functions, the administrators' workload is reduced to just the essential tasks.

Rittal has developed its own web-based configurator with integrated CFD (computational fluid dynamics) analysis for edge data centre planning, to selectively optimise the enclosure and IT room climate control to the predefined ambient conditions.

For further information on the Edge Data Center, please visit our IT website at www.rittal.com/it-solutions/en

Your benefits at a glance:

- Modular and easy to extend
- Fully pre-configured for plug & play assembly
- Straightforward planning with configurator

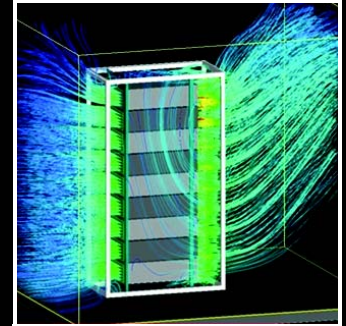

CFD (computational fluid dynamics) takes into account the geometrical and thermal properties of the enclosure and the installed components, and generates a thermal image.



Computer Multi Control III (CMC III) monitors temperature, air humidity, smoke, energy and access. The CAN (Controller Area Network) bus system reduces the amount of wiring and installation work required.



IT INFRASTRUCTURE

SOFTWARE & SERVICES



Enjoy the perfect spa experience



“Rittal’s knowledgeable consultants gave us in-depth expert advice. We felt they understood the challenges facing a thermal facility of this size, spread over multiple sites. The fact that we can still be flexible with the assembly and expansion of the IT systems, despite the high level of standardisation, reinforced our decision.”

Franz Hofstetter
Head of IT at the WUND Group

ENCLOSURES

POWER DISTRIBUTION

CLIMATE CONTROL

When large volumes of data are processed around-the-clock so that customers can rely on smooth operations, a failure in the data centre IT systems is business-critical. With this in mind, the WUND Group uses autonomous edge data centres and standardisation from Rittal for its thermal spa facilities across Germany.

High availability in continuous operation

If its IT systems were to malfunction, the WUND Group could face financial losses or damage to its reputation. High availability of the data was therefore an important factor when opting for an IT infrastructure from Rittal. A separate technical room is provided for the modular, redundant UPS system and power distributors. The Rittal Liquid Cooling Packages and cold aisle encapsulation provide rack suite-based cooling in the server room. Cooling is generated via indirect free cooling.

Future-safe, thanks to maximum standardisation

The high availability necessitated autonomous data centres at the Group's locations. Highly standardised, virtually identical data centres make life easier by facilitating rapid intervention at any time if problems do arise. Although the individual systems function independently of one another, the option of extending the IT infrastructure and associated processes simplifies operation, and were ultimately the deciding factor in favour of Rittal.



IT INFRASTRUCTURE

SOFTWARE & SERVICES



High-performance computing with efficient cooling

High power density is a key requirement in high-performance computing (HPC), where there may be several thousand processors in a single IT rack. And because a latest-generation CPU generates more heat than a hotplate, an increase in power density places great demands on the cooling system.

When HPC cluster simulations or other computation-intensive applications are running, the processor cores can often be operating at full load for days at a time. When that happens, every single processor generates enormous quantities of waste heat, which must be reliably dissipated. This task is often made more difficult by the fact that the rack systems are packed so full.

An HPC cooling system must therefore generate a high cooling output of up to 55 kW per rack while also minimising the volume of air, ensure that cooling is dynamically adapted when the blade servers are switched on and off, and protect the expensive hardware if individual components fail.

TS IT racks and Liquid Cooling Packages (LCP) from Rittal meet all these requirements and are ideal for modern-day data centres where powerful server nodes introduce increasingly high loads and waste heat into the server racks.

The space-optimised LCP Inline CW solution from Rittal is a compact water-based cooling solution for simple suite cooling, including cooling of HPC centres. An air/water heat exchanger unit is installed directly adjacent to the IT racks. The warm waste air from the IT systems is extracted at the rear of the unit, cooled and then blown into the cold aisle at the front. Maximum efficiency is achieved in combination with an aisle containment system.

Monitoring and remote management can deliver lasting maintenance and operating cost savings and also increase availability. For example, comprehensive monitoring, measurement and control tasks minimise the risk of failure and facilitate preventive intervention.

In the case of emergency cooling with automatic door opening, for instance, the doors of the IT racks open automatically if an alarm is triggered. This means the cold air in the data centre room can be used

to shut down the HPC cluster in a controlled manner for a certain period of time.

Rittal's HPC racks are based on the TS IT platform. The options for flexibly expanding this system ensure a high level of investment security. An intelligent modular system of racks and accessories and the assembly-friendly snap-in technology cover just about every conceivable requirement with regard to modular, flexible network and server racks.

For further information on high-performance computing with efficient cooling, please visit our IT website at www.rittal.com/it-solutions/en

Your benefits at a glance:

- Individual climate control concepts for rack, suite and room cooling
- Monitoring of all system-relevant parameters
- Tried-and-tested system solutions for demanding HPC applications

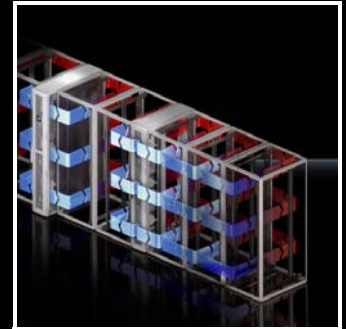

Bayed suite cooling with the Rittal LCP Inline is extremely powerful, and the ideal climate control solution for exceptionally high cooling demands, particularly when server racks cannot be cooled via the room air-conditioning system.



The comprehensive PDU range delivers smart power distribution in IT racks with measuring, switching and monitoring – right down to each individual slot if necessary.

IT INFRASTRUCTURE

SOFTWARE & SERVICES



A data centre for Industry 4.0 requirements



“In the Micro Data Center from Rittal, we have found a solution which enables us to operate a secure, redundant data centre without having to implement any complex structural measures.”

Werner Mielenbrink
Head of Media Supply at B. Braun

The experts at B. Braun, one of the world's leading manufacturers of medical technology and pharmaceutical products, faced a serious challenge when their brand new, state-of-the-art production facility called for a rapid expansion of the IT infrastructure.

Highly available, compact and safe

IT infrastructure requires around half-a-dozen server enclosures. Originally, the team had planned to use simple server enclosures to assemble the IT infrastructure, but the physical protection requirements for the IT system could not be met in this way.

The solution: Rittal Micro Data Center

A solution was found in the Micro Data Center from Rittal, a data safe for IT systems. The solution delivers the required fail-safeness and modularity for automated production to Industry 4.0. IT components such as the server, storage and network are operated in a protected room up to resistance class 4. Chains of 3 and 4 Micro Data Centers, each containing a complete, redundant IT environment consisting of three or four IT racks including cooling, power distribution, monitoring and fire protection, are created. The server enclosures are cooled by the integral split climate control unit LCU DX (Liquid Cooling Unit) from Rittal.

Central monitoring

B. Braun puts its trust in the Rittal CMC III solution for monitoring the entire system. This application allows central monitoring of key parameters in all aspects of IT operation, such as temperature and humidity. The fire and extinguisher system DET-AC, also integrated, detects even minuscule particles of smoke in the air and sends a pre-alarm to an engineer. In the event of a fire, DET-AC floods the IT enclosure with the extinguisher gas Novec 1230, which is non-harmful to IT components.





Compact IT infrastructures demand compact solutions

Every IT decision-maker is familiar with the imposing images of enormous data centres. They look almost futuristic, with their seemingly endless aisles, flanked on either side by flashing component towers.

By contrast, IT infrastructures comprised of just one or two enclosures are rather less impressive, but must still demonstrate all the features of a large data centre, from a reliable power supply and cooling, through to monitoring.

Cooling is based on the output of the installed active components. Rittal offers a wide selection of different cooling solutions.

The Liquid Cooling Unit (LCU) is used for the small output range from 3 kW to 6.5 kW. The internal part is discretely and space-savingly installed inside the enclosure. Refrigerant lines transport waste heat to the external part, which is sited outside on the external wall or on the roof.

If larger heat losses are incurred, a Liquid Cooling Package (LCP) DX can be bayed to the side of the rack, for cooling one or two IT racks with a total output of up to 35 kW.

The extensive range of system accessories includes all the additional products needed for tidy air routing, together with socket systems, cable routing and cable management. The coordinated components in the Rittal modular system may be flexibly selected for a bespoke and efficient solution.

For further information on compact IT infrastructures, please visit our IT website at www.rittal.com/it-solutions/en

Your benefits at a glance:

- Flexible cooling solution in the output range from 3 kW to 6.5 kW
- Space-saving installation inside the enclosure
- Minimal space requirements for the redundant version with two cooling circuits in one unit
- Extensive range of coordinated system accessories



The LCP DX can be used for rack-based climate control, and also for suite climate control within the context of aisle containment.



If larger cooling outputs are required, the LCP DX offers a solution in the output range from 12 to 35 kW.



IT INFRASTRUCTURE

SOFTWARE & SERVICES



IT cooling – Rittal solutions

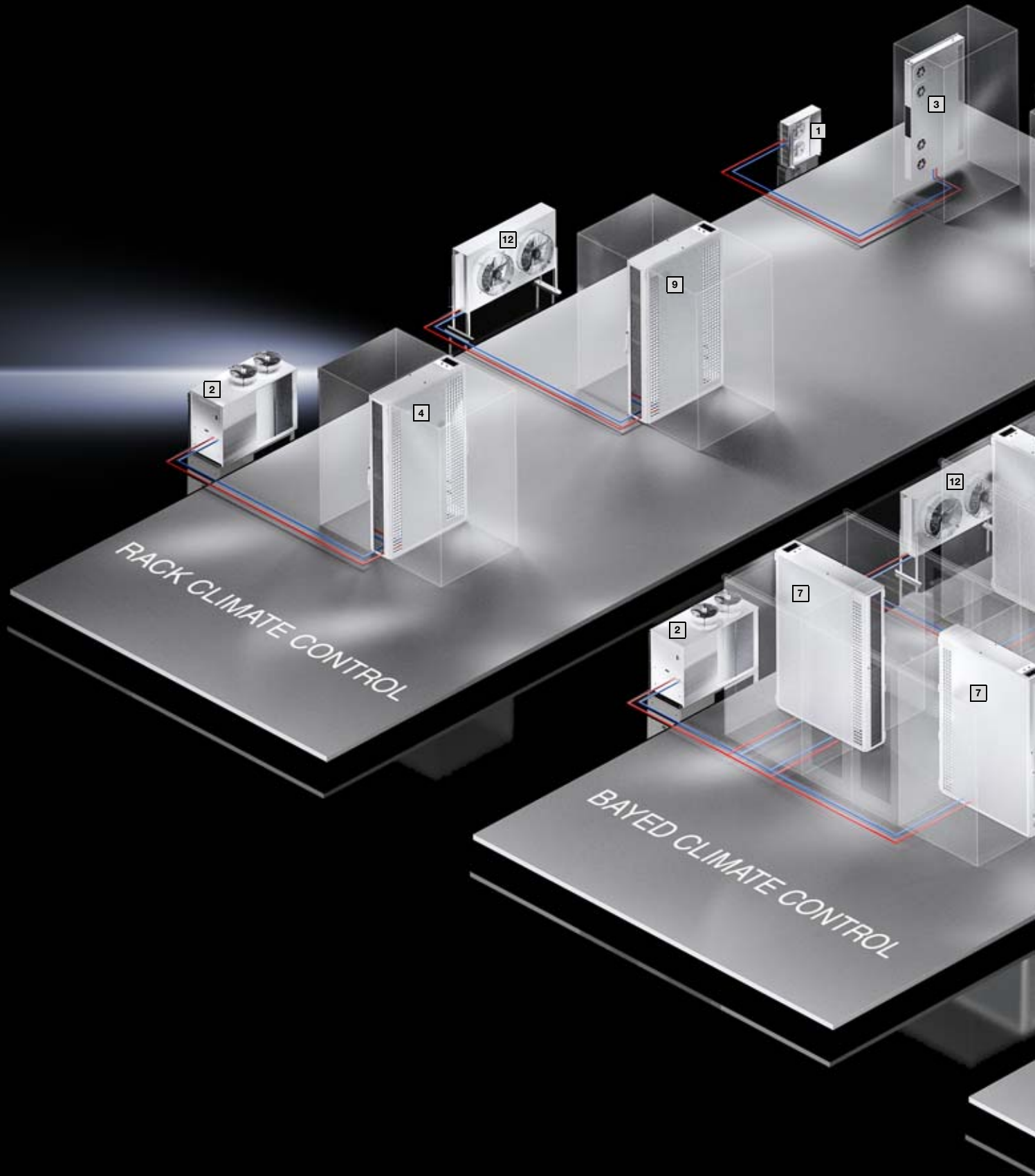

ENCLOSURES

POWER DISTRIBUTION

CLIMATE CONTROL

FRIEDHELM LOH GROUP

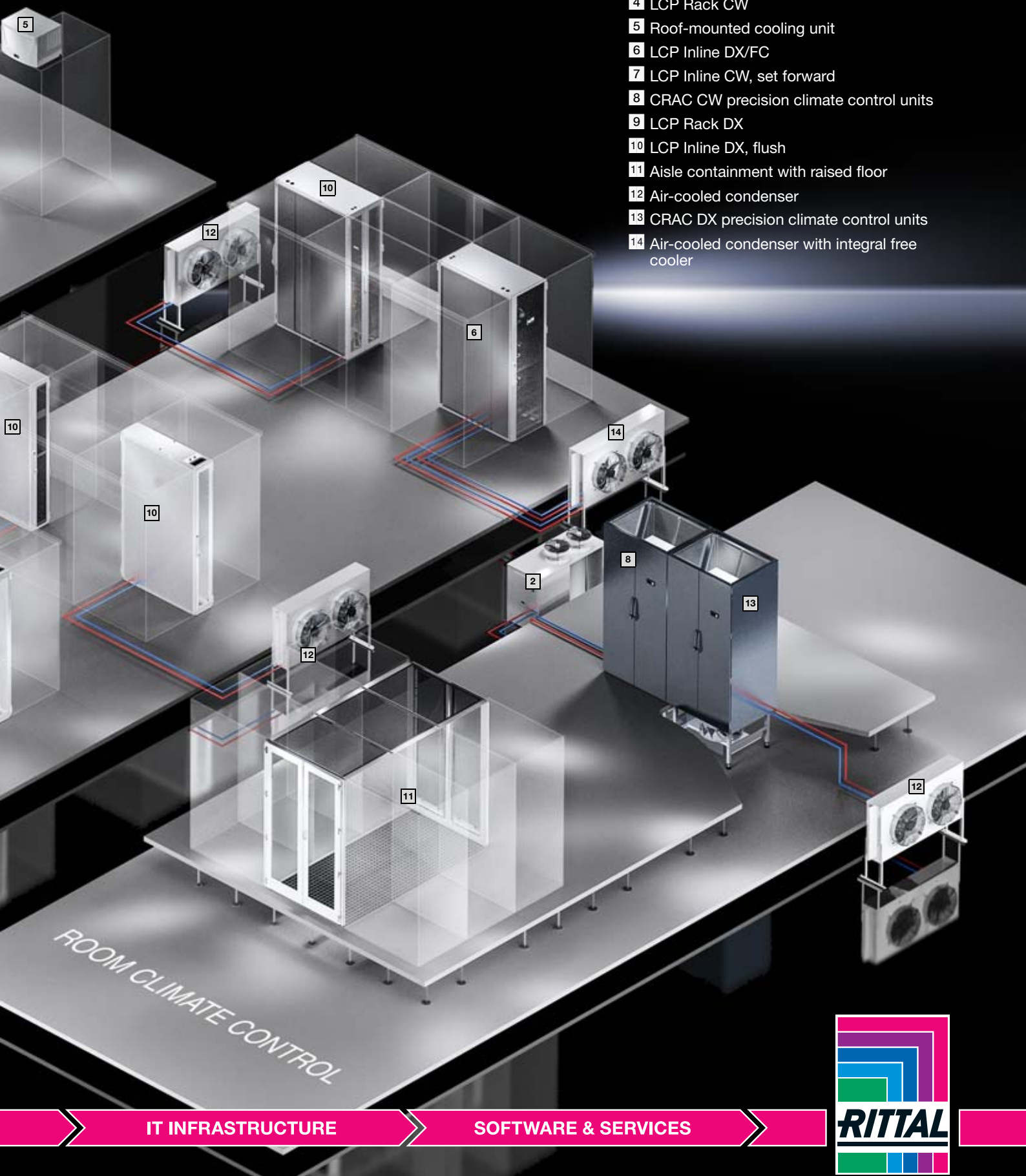

- 1** Inverter-controlled external unit
- 2** IT chiller
- 3** LCU DX
- 4** LCP Rack CW
- 5** Roof-mounted cooling unit
- 6** LCP Inline DX/FC
- 7** LCP Inline CW, set forward
- 8** CRAC CW precision climate control units
- 9** LCP Rack DX
- 10** LCP Inline DX, flush
- 11** Aisle containment with raised floor
- 12** Air-cooled condenser
- 13** CRAC DX precision climate control units
- 14** Air-cooled condenser with integral free cooler

IT INFRASTRUCTURE

SOFTWARE & SERVICES



Overview of rack/bayed suite cooling

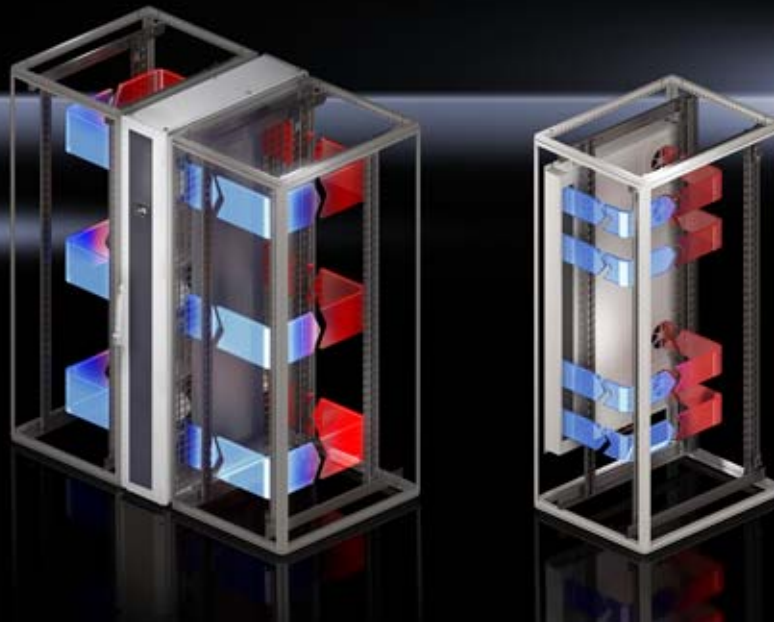

Rack cooling

Water-based

Data centres support ever more powerful corporate processes. The packing density in computer systems is increasing, and processor capacity is growing. This in turn means ever higher heat generation. Keep temperatures at a constant level with the highly efficient Rittal Liquid Cooling Packages (LCP). With optimised operating costs, our LCPs precisely and effortlessly dissipate heat losses of up to 53 kW per enclosure.

LCP Rack CW

- Cooling output from 10 kW to 53 kW
- Energy saving with high water inlet temperatures (more free cooling)
- Minimised operating costs thanks to efficient EC fan technology
- Spatial separation of cooling and server rack
- Integral condensate and leak management
- Highly developed control concept including online connection
- Optional cooling of one or two server racks
- Optimised variants available for cooling with water/glycol mixtures
- Ideal in conjunction with a heat pump, as the LCP CW glycol variants generate high water return temperatures
- Simple representation of redundancies
- Assembly- and service-friendly – maintenance from above is no longer necessary
- Integration into RiZone (data centre management software)

Refrigerant-based

The ideal cooling solution for small to medium IT installations. Up to 6.5 kW heat load can be dissipated with the inverter-controlled LCU DX split cooling unit. The LCP Rack DX has a cooling output of 12 kW and is capable of cooling up to two server racks. Both units are inverter-controlled, allow IT-compatible cooling, and regulate the server inlet air temperature. The external unit dissipates thermal energy directly to the exterior air, thereby preventing the server rack installation location from heating up. Rack cooling with the typical “back-to-front” air routing used in IT can be achieved with the roof-mounted cooling unit, even for smaller output categories up to 3 kW.

LCP Rack DX

- Cooling output up to 12 kW
- Refrigerant R410a
- Minimised operating costs thanks to efficient EC fan technology and output-regulated compressor
- Spatial separation of cooling and server rack
- Integral condensate and leak management
- Highly developed control concept including online connection
- Optional cooling of one or two server racks
- Simple representation of redundancies
- Assembly- and service-friendly
- Direct connection of the unit via SNMP over Ethernet
- Integration into RiZone (data centre management software)
- Cost-effective installation by laying small-diameter refrigerant lines

LCU DX

- Cooling outputs of up to 3 kW and up to 6.5 kW
- Single and redundant version
- Refrigerant R410a
- High energy efficiency thanks to EC fan technology and output-regulated compressor
- Space-saving installation of the internal unit (evaporator coil) in the server rack

Roof-mounted cooling unit

- Cooling output up to 3 kW
- Refrigerant R134a
- “Front-to-back” air routing typical of IT systems
- Even air distribution in front of the 482.6 mm (19”) level
- Control of the server air inlet temperature
- External circuit IP 20
- Internal circuit IP 20

Overview of rack/bayed suite cooling

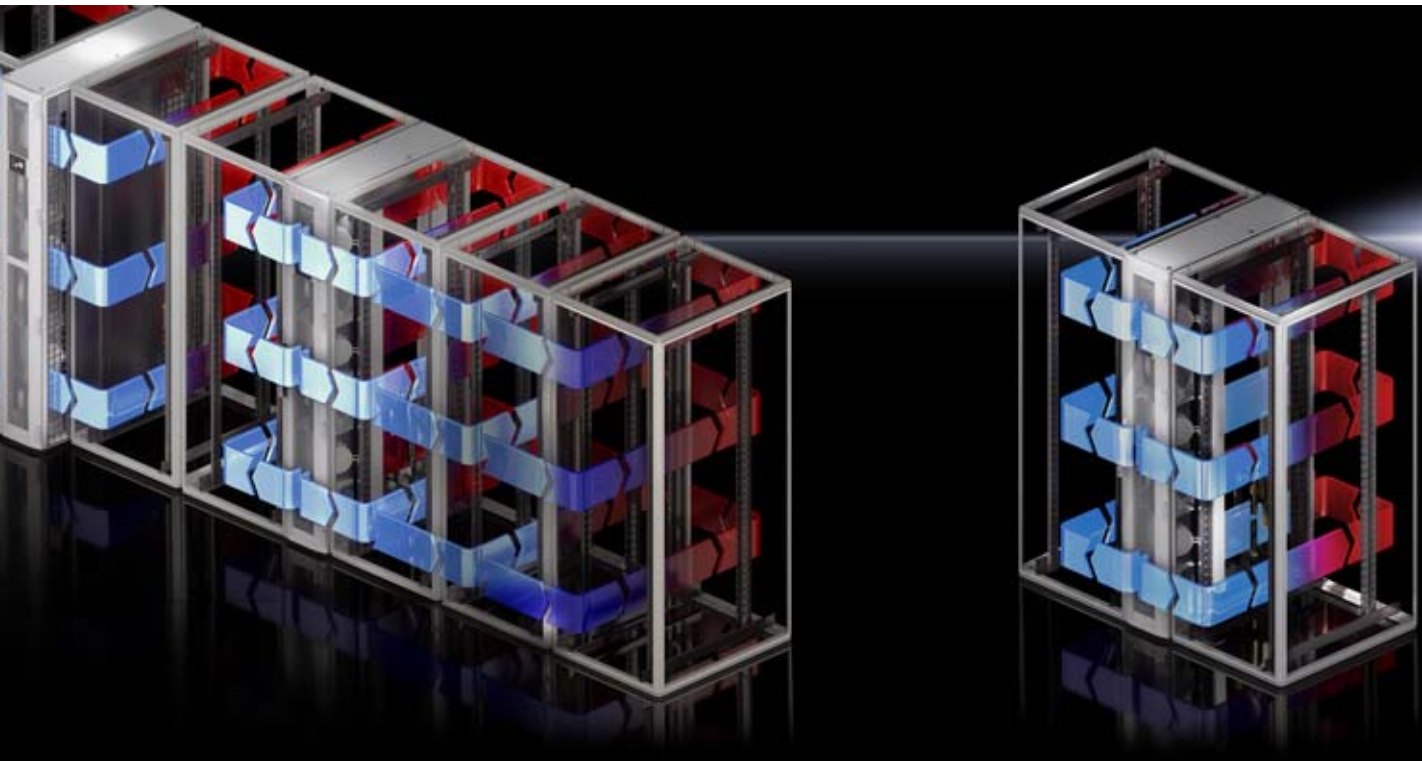

Bayed suite cooling

Water-based	Refrigerant-based	Refrigerant and water/glycol
<p>Bayed suite cooling with the Rittal LCP Inline is extremely powerful and the ideal climate control solution for exceptionally high cooling demands, particularly when server racks cannot be cooled via the room climate control.</p> <p>Alternatively, bayed suite cooling can be used to support the existing climate control system in the room or for transforming existing structures into server rooms. A raised floor is not necessary for the operation of bayed suite cooling.</p>	<p>Both the LCP DX Inline and the LCP CW Inline support the cooling of bayed enclosure suites. A raised floor is not required for the LCP DX Inline. The cooling output is up to 35 kW. The Inline units are generally used in conjunction with aisle containment.</p>	<p>These LCP DX/FC variants include both a refrigerant and a water/glycol heat exchanger. There is an additional free cooler integrated into the external condenser. Using indirect free cooling helps to save operating costs.</p>
<p>LCP Inline CW</p> <ul style="list-style-type: none"> ■ Cooling output from 10 kW to 53 kW ■ Cooling of several server racks ■ Energy saving with high water inlet temperatures (more free cooling) ■ Minimised operating costs with efficient EC fan technology ■ Spatial separation of cooling and server rack ■ Integral condensate and leak management ■ Sophisticated control concept including online connection ■ Assembly- and service-friendly – maintenance from above is no longer necessary ■ Optimised variants available for cooling with water/glycol mixtures ■ Ideal in conjunction with a heat pump, as the LCP CW glycol variants generate high water return temperatures ■ Increased performance and efficiency in conjunction with Rittal aisle containment ■ Direct connection of the unit via SNMP over Ethernet ■ Integration into RiZone (data centre management software) ■ Set-forward variant for ideal air distribution (cold air curtain) ■ Flush variant for confined spaces (narrow cold aisle) 	<p>LCP Inline DX</p> <ul style="list-style-type: none"> ■ Cooling output from 12 kW to 35 kW ■ Cooling of several server racks ■ Refrigerant R410a ■ Variants available in widths 300 mm and 600 mm ■ Minimised operating costs with efficient EC fan technology ■ Spatial separation of cooling and server rack ■ Integral condensate and leak management ■ Sophisticated control concept including online connection ■ Assembly- and service-friendly ■ Increased performance and efficiency in conjunction with Rittal aisle containment ■ Direct connection of the unit via SNMP over Ethernet ■ Integration into RiZone (data centre management software) 	<p>LCP Inline DX/FC</p> <ul style="list-style-type: none"> ■ Cooling output up to 35 kW ■ Cooling of multiple server racks ■ Refrigerant R410a and water/glycol mixture ■ External condenser with additional, integral free cooler ■ Minimised operating costs with efficient EC fan technology and indirect free cooling ■ Automatic control between free cooling, mixed and compressor mode ■ Spatial separation of cooling and server rack ■ Integral condensate and leak management ■ Highly developed control concept including online connection ■ Assembly- and service-friendly ■ Increased performance and efficiency in conjunction with Rittal aisle containment ■ Direct connection of the unit via SNMP over Ethernet ■ Integration into RiZone (data centre management software)

LIQUID COOLING UNIT DX

Efficient cooling with no loss of space



The benefits

- Cooling of TS IT racks and Micro Data Centers
- Space-saving installation of the internal unit between the 482.6 mm (19") level and side panel
- External unit is sited outside the building
- Maximum energy efficiency by cooling the individual rack, rather than the whole room
- Efficient operation thanks to EC fan technology
- High availability designed for continuous, 24/7 operation

Technology

- Refrigerant-based split cooling unit comprised of an internal unit (evaporator coil) and an external unit with integral compressor (inverter-controlled)
- Optimum support of IT-compatible, "front-to-back" air routing
- Optimum adaptation of the compressor output to the current heat load of the IT rack with inverter control
- The internal and external unit are connected with refrigerant, data and supply lines
- Absorbed thermal energy is emitted directly to the ambient air via the external unit
- Control of the server air inlet temperature
- The availability of single and redundant variant ensures a high level of fail-safeness.
- Ultimate security with optional alarm forwarding via CMC III

Control

- Set the setpoint for the server air inlet temperature
- Switch the unit on and off

For further information on efficient cooling with no loss of space, please visit our IT website at www.rittal.com/it-solutions/en

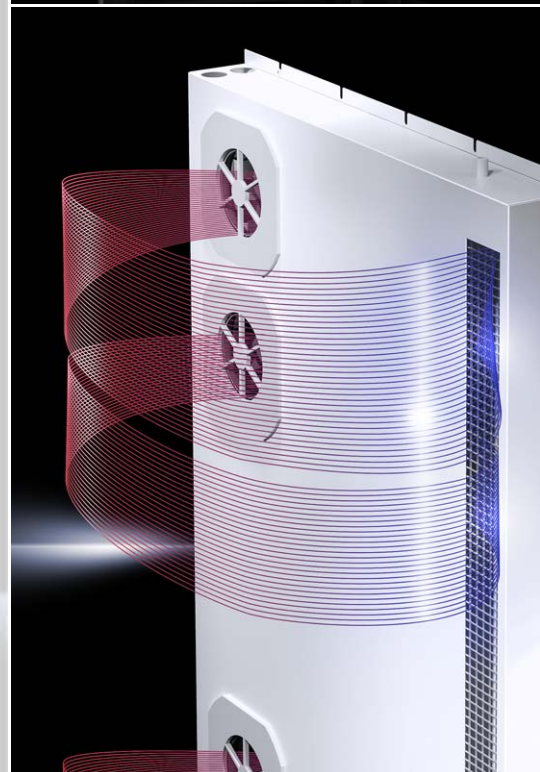
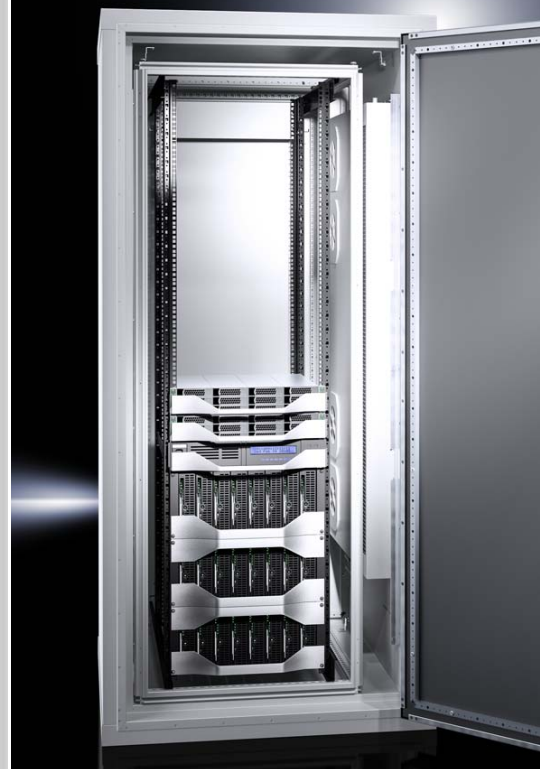

Liquid Cooling Unit



Network/server enclosures TS IT Cat. 35, page 104 Micro Data Center Cat. 35, page 566

Applications:

- Cooling unit for TS IT server enclosures and for Micro Data Center

Benefits:

- Space-saving solution by installing the internal unit in the TS IT server enclosure or the Micro Data Center
- Maximum energy efficiency due to EC fan technology and IT-based control
- Control of the server inlet temperature
- The inverter-controlled compressor adapts the cooling output to the current heat loss inside the enclosure
- Absorbed thermal energy is emitted directly to the ambient air at the (inverter-controlled) external unit's location, without heating up the installation room

Functions:

- The device supports front-to-back air routing typical of IT applications, and regulates the server inlet temperature to the set value

Colour:

- Internal unit: RAL 7035
- External unit: white

Protection category IP to IEC 60 529:

- Internal unit IP 20
- External unit IP X4

Supply includes:

- Internal unit (evaporator coil)
- External unit (inverter-controlled)
- 482.6 mm (19") mounting trim panel with display and control components
- Condensate hose

Note:

- Below the operating limit, fluctuations in the air inlet temperature are possible
- The electrical connection is made on the external unit. The internal unit is supplied by the external unit.

Installation in TS IT:

- 482.6 mm (19") levels must be designed as mounting angles and offset in the width by 50 mm off-centre
- The front distance between the 482.6 mm (19") mounting angles and the front edge of the TS frame must be at least 100 mm
- Not suitable for combination with 482.6 mm (19") mounting frame
- Two punched sections with mounting flanges are required for attachment on the inner mounting level
- To separate the hot/cold zones within an enclosure, an air baffle plate for TS IT is required
- A base/plinth is required to route the cable downwards

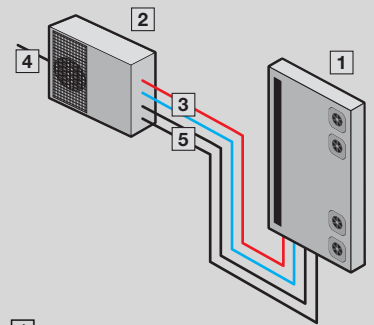

- 1 Internal unit
- 2 External unit
- 3 Refrigerant lines
- 4 Power supply
- 5 Data cable

LCU DX, single

Model No.	Packs of	3311.490	3311.492	Page
Useful cooling output L22 L35 kW		3	6.5	
Modulation range kW		1 - 3	3 - 6.5	
For enclosure width mm		800	800	
For enclosure height mm		≥ 1800	≥ 1800	
For enclosure depth mm		≥ 1000	≥ 1000	
External unit, W x H x D mm		810 x 558 x 310	845 x 700 x 320	
Internal unit, W x H x D mm		105 x 1550 x 820	105 x 1550 x 820	
Type of electrical connection		Connection clamp	Connection clamp	
Rated operating voltage V, ~, Hz		230, 1~, 50	230, 1~, 50	
Rated current (max.) A		7	15.9	
Pre-fuse A		16	20	
Refrigerant		R410a	R410a	
Duty cycle %		100	100	
Sound pressure level at a distance of 10 m (external unit) dB(A)		40	40	
Operating temperature range (external unit)		-20°C...+45°C	-20°C...+45°C	
Weight as delivered kg		116.0	121.5	
Accessories				
Refrigerant lines	1 pc(s).	3311.495	3311.496	40

Rittal Quick-Check – know what's going on!

The IT Quick-Check allows our service experts to assess the current status. The Rittal service expert will assess your IT infrastructure with regard to:

- Energy efficiency
- Maintenance status
- Leaks
- Obsolescence risk of products and systems
- Review of alarm chains
- Statutory requirements, guidelines, standards

You will then receive an assessment report indicating your options for optimisation, including identified cost drivers and potential savings.

Arrange a service appointment now for an IT Quick-Check!

servicesales@rittal.de
+49(0) 2772 505-1717



Liquid Cooling Unit



Network/server enclosures TS IT Cat. 35, page 104 Micro Data Center Cat. 35, page 566

Applications:

- Cooling unit for TS IT server enclosures and for Micro Data Center in a redundant design

Benefits:

- Space-saving solution by installing the redundantly designed internal unit in the TS IT server enclosure or the Micro Data Center
- Maximum energy efficiency due to EC fan technology and IT-based control
- Control of the server inlet temperature
- The inverter-controlled compressor adapts the cooling output to the current heat loss inside the enclosure
- Absorbed thermal energy is emitted directly to the ambient air at the (inverter-controlled) external unit's location, without heating up the installation room

Functions:

- The redundant variants have two cooling circuits and controllers inside the internal unit, plus two inverter-regulated external units. The fault and operating hours changeover allows regular switching between the two external units, and ensures automatic changeover in the event of a malfunction or failure.
- The device supports front-to-back air routing typical of IT applications, and regulates the server inlet temperature to the set value

Colour:

- Internal unit: RAL 7035
- External unit: white

Protection category IP to IEC 60 529:

- Internal unit IP 20
- External unit IP X4

Supply includes:

- Internal unit (evaporator coil)
- 2 external units (inverter-controlled)
- 482.6 mm (19") mounting trim panel with display and control components
- Condensate hose

Note:

- Below the operating limit, fluctuations in the air inlet temperature are possible
- The electrical connection is made on the external unit. The internal unit is supplied by the external unit.
- A separate power supply may be needed, depending on the external unit

Installation in TS IT:

- 482.6 mm (19") levels must be designed as mounting angles and offset in the width by 50 mm off-centre
- The front distance between the 482.6 mm (19") mounting angles and the front edge of the TS frame must be at least 100 mm
- Not suitable for combination with 482.6 mm (19") mounting frame
- Two punched sections with mounting flanges are required for attachment on the inner mounting level
- To separate the hot/cold zones within an enclosure, an air baffle plate for TS IT is required
- A base/plinth is required to route the cable downwards

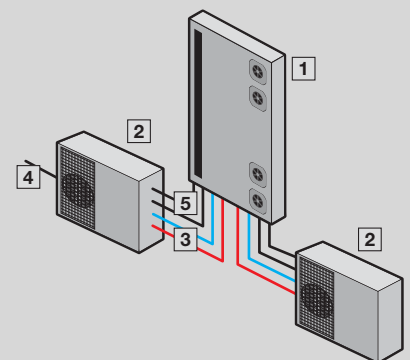

- 1 Internal unit
- 2 External unit
- 3 Refrigerant lines
- 4 Power supply
- 5 Data cable

LCU DX, redundant

Model No.	Packs of	3311.491	3311.493	Page
Useful cooling output L22 L35 kW		3	6.5	
Modulation range kW		1 - 3	3 - 6.5	
For enclosure width mm		800	800	
For enclosure height mm		≥ 1800	≥ 1800	
For enclosure depth mm		≥ 1000	≥ 1000	
External unit, W x H x D mm		810 x 558 x 310	845 x 700 x 320	
Internal unit, W x H x D mm		105 x 1550 x 820	105 x 1550 x 820	
Type of electrical connection		Connection clamp	Connection clamp	
Rated operating voltage V, ~, Hz		230, 1~, 50	230, 1~, 50	
Rated current (max.) A		7	15.9	
Pre-fuse A		16	20	
Refrigerant		R410a	R410a	
Duty cycle %		100	100	
Sound pressure level at a distance of 10 m (external unit) dB(A)		40	40	
Operating temperature range (external unit)		-20°C...+45°C	-20°C...+45°C	
Weight as delivered kg		161.0	184.0	
Accessories				
Refrigerant lines	1 pc(s).	3311.495	3311.496	40

Micro Data Center Configurator – For individual configuration of your security safe

Rittal Configurator



Configure your security safe, including a range of components.

- Your complete Micro Data Center in just a few steps
- Individual selection of components
- When you have finished, you can request a quote for your current configuration

The configurator is available at:
www.rittal.com/mdc-configurator

The latest output categories in bayed suite cooling



The benefits

LCP Inline DX

- New output categories: 20 kW and 35 kW
- Minimal power consumption thanks to an inverter-controlled compressor

LCP Inline DX/FC

- New variant with integral refrigerant and additional water/glycol heat exchanger
- Minimised operating costs with optimum use of indirect free cooling
- Minimal power consumption thanks to inverter-regulated pumps compressors

Technology

LCP Inline DX/FC

- External hybrid condenser with refrigerant for indirect free cooling, mixed and pure compressor modes
- Automatic control between free cooling, mixed and compressor mode
- Integral inverter-controlled pump
- Expansion tank integrated into the water circuit, plus safety components
- External condenser with integral free cooler

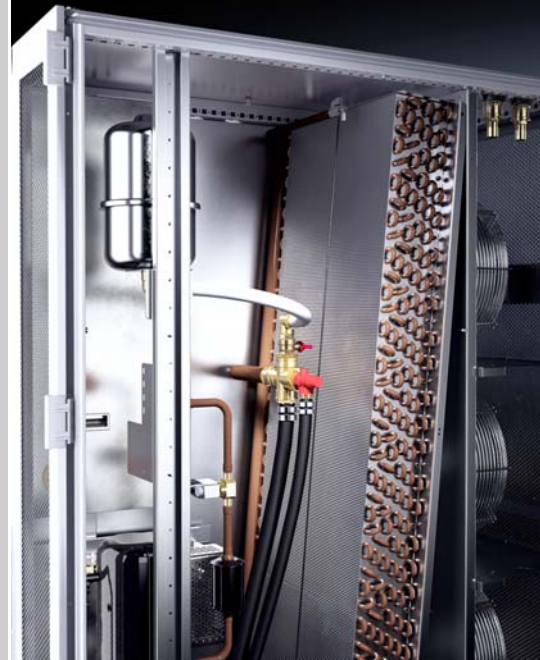

Distribution of hours among the various operating modes, Munich

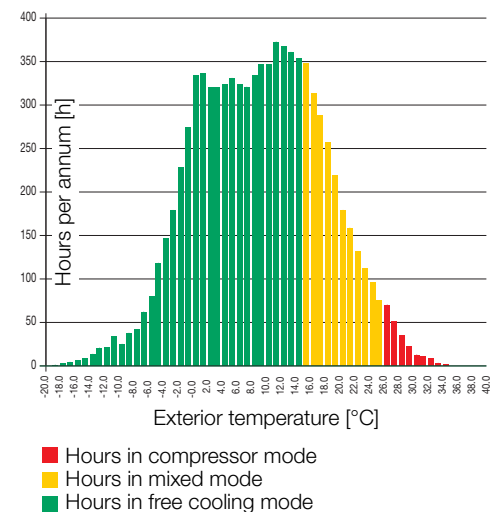

For further information on the new output categories in bayed suite cooling, please visit our IT website at www.rittal.com/it-solutions/en

Liquid Cooling Package



Accessories for IT cooling Page 40 Network/server enclosures TS IT Cat. 35, page 104 System accessories Cat. 35, page 613

Applications:

- Ideal for IT cooling of small and medium-sized locations
- One or two racks can be cooled separately

Benefits:

- Maximum energy efficiency due to EC fan technology and IT-based control
- Minimal pressure loss at the air end, which in turn minimises the power consumption of the fans
- Control of the server inlet temperature

- Thanks to the speed-regulated compressor, the cooling output is ideally adapted to actual requirements
- With redundant temperature sensor integrated at the air end as standard
- Specific maintenance of the LCP DX due to separation of cooling and server racks

Functions:

- The LCP draws in the air at the sides at the rear of the server enclosures, cools it using high-performance compact impellers, and blows the cooled air back into the front part of the server enclosure at the sides

- Absorbed thermal energy is emitted to the ambient air at the external condenser location, without heating up the installation room

IT monitoring:

- Direct connection of the unit via SNMP over Ethernet
- Integration into RiZone

Temperature control:

- Linear fan control
- Inverter-controlled compressor

Colour:

- RAL 7035

Protection category IP to IEC 60 529:

- IP 20

Optional:

- Humidifier
- Dehumidification and reheater
- Condensate drain pump
- Higher cooling output
- Low-temperature/high-temperature condenser (-40°C / +53°C)

Note:

- Variant with UL approval available on request

Photo shows a configuration example with equipment not included in the scope of supply

LCP Rack DX

Model No.	Packs of	3311.410	3311.420	Page
Modulation range kW		3 - 12	3 - 12	
Total cooling output/Number of fan modules required kW		12 / 4	12 / 4	
Width mm		300	300	
Height mm		2000	2000	
Depth mm		1000	1200	
Type of electrical connection		Connection clamp	Connection clamp	
Installation in bayed enclosure suite		Flush	Flush	
Rated operating voltage V, ~, Hz		400, 3~, 50 380 - 480, 3~, 60	400, 3~, 50 380 - 480, 3~, 60	
Pre-fuse (T) A		20	20	
Air throughput at max. cooling output m ³ /h		4800	4800	
Fans may be exchanged with the system operational		■	■	
EC fan		■	■	
Rated current max. A		7.5	7.5	
Refrigerant		R410a	R410a	
Duty cycle %		100	100	
Operating temperature range		+15°C...+35°C	+15°C...+35°C	
Weight as delivered kg		207.0	227.0	
Also required				
Condenser unit	1 pc(s).	3311.360	3311.360	40
Accessories				
SNMP card	1 pc(s).	3311.320	3311.320	41

Liquid Cooling Package



Accessories for LCP Page 40 Network/server enclosures TS IT Cat. 35, page 104 Aisle containment Page 48

Applications:

- Ideal for IT cooling of small and medium-sized locations
- One or two racks can be cooled separately

Benefits:

- Maximum energy efficiency due to EC fan technology and IT-based control
- Minimal pressure loss at the air end, which in turn minimises the power consumption of the fans
- Temperature monitoring and control
- With redundant temperature sensor integrated at the air end as standard

- Thanks to the speed-regulated compressor, the cooling output is ideally adapted to actual requirements
- Specific maintenance of the LCP DX due to separation of cooling and server racks
- Using indirect free cooling helps to save operating costs

Functions:

- The LCP is designed for siting within a bayed enclosure suite. Hot air is drawn in from the aisle at the rear of the device, cooled by the high-capacity compact impellers, and blown back into the room or cold aisle after cooling

- The LCP DX/FC variants include both a refrigerant and a water/glycol heat exchanger. There is an additional free cooler integrated into the external condenser.
- Absorbed thermal energy is emitted to the ambient air at the external condenser location, without heating up the installation room

IT monitoring:

- Direct connection of the unit via SNMP over Ethernet
- Integration into RiZone

Temperature control:

- Linear fan control
- Inverter-controlled compressor

Colour:

- RAL 7035

Protection category IP to IEC 60 529:

- IP 20

Optional:

- Humidifier
- Dehumidification and reheater
- Condensate drain pump
- Higher cooling output
- Air filter
- Low-temperature/high-temperature condenser (-40°C / +53°C)

Note:

- Variant with UL approval available on request

Photo shows a configuration example with equipment not included in the scope of supply

LCP Inline DX

Model No.	Packs of	3311.390	3311.430	3311.440	3311.450	Page
Modulation range kW		6 - 20	3 - 12	3 - 12	8 - 35	
Total cooling output/Number of fan modules required kW		20 / 4	12 / 4	12 / 4	35 / 3	
Width mm		300	300	300	600	
Height mm		2000	2000	2000	2000	
Depth mm		1200	1000	1200	1000	
Type of electrical connection		Connection clamp	Connection clamp	Connection clamp	Connection clamp	
Installation in bayed enclosure suite		Flush	Flush	Flush	Flush	
Rated operating voltage V, ~, Hz		400, 3~, 50 380 - 480, 3~, 60	400, 3~, 50 380 - 480, 3~, 60	400, 3~, 50 380 - 480, 3~, 60	360, 3~, 50 480, 3~, 60	
Pre-fuse (T) A		32	20	20	40	
Air throughput at max. cooling output m ³ /h		4800	4800	4800	9900	
Fans may be exchanged with the system operational		■	■	■	■	
EC fan		■	■	■	■	
SNMP card		■	-	-	■	
Rated current max. A		12.4	7.5	7.5	22.4	
Cooling medium		-	-	-	-	
Refrigerant		R410a	R410a	R410a	R410a	
Duty cycle %		100	100	100	100	
Operating temperature range		+35°C	+15°C...+35°C	+15°C...+35°C	+15°C...+35°C	
Weight as delivered kg		201.0	208.0	233.5	398.0	
Also required						
Condenser unit	1 pc(s).	3311.363	3311.360	3311.360	3311.370	40
Accessories						
SNMP card	1 pc(s).	-	3311.320	3311.320	-	41

Liquid Cooling Package

LCP Inline DX

Model No.	Packs of	3311.460	3311.470	3311.480	Page
Modulation range kW		8 - 35	8 - 35	8 - 35	
Total cooling output/Number of fan modules required kW		35 / 3	35 / 3	35 / 3	
Width mm		600	600	600	
Height mm		2000	2000	2000	
Depth mm		1000	1200	1200	
Type of electrical connection		Connection clamp	Connection clamp	Connection clamp	
Installation in bayed enclosure suite		Flush	Flush	Flush	
Rated operating voltage V, ~, Hz		400, 3~, 50 380 - 480, 3~, 60	400, 3~, 50 380 - 480, 3~, 60	400, 3~, 50 380 - 480, 3~, 60	
Pre-fuse (T) A		40	40	40	
Air throughput at max. cooling output m ³ /h		9900	9900	9900	
Fans may be exchanged with the system operational		■	■	■	
EC fan		■	■	■	
SNMP card		■	■	■	
Rated current max. A		31.6	22.4	31.6	
Cooling medium		Water/glycol	-	Water/glycol	
Refrigerant		R410a	R410a	R410a	
Duty cycle %		100	100	100	
Operating temperature range		+15°C...+35°C	+15°C...+35°C	+15°C...+35°C	
Weight as delivered kg		398.0	398.0	398.0	
Also required					
Condenser unit	1 pc(s).	3311.380	3311.370	3311.380	40
Accessories					
SNMP card		-	-	-	41

NEW: Container Platform



Modular data centres in containers

www.rittal.com/container-platform



The Rittal service for your climate control!

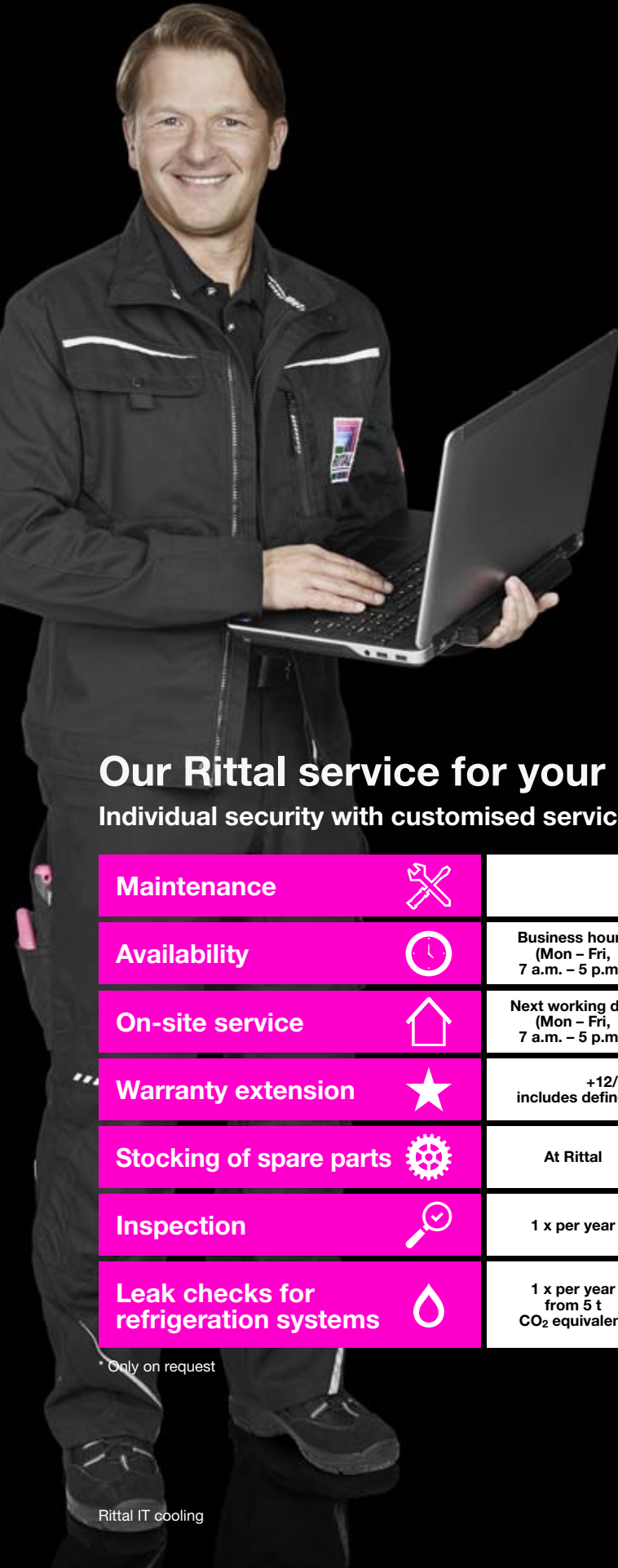

Our expertise:







- All services from a single source
- Manufacturer expertise
- Qualified technicians with an in-depth knowledge of Rittal products and training in refrigeration engineering
- Proximity to the customer
- Short response times

The Rittal service portfolio:

- Fast trouble-shooting
- Professional maintenance
- Configuration, assembly, installation and commissioning
- Original spare parts
- Modular service agreements
- Advice on efficiency and applications
- Modernisation

Our Rittal service for your data centre

Individual security with customised service agreements

Maintenance 	1 x per year		2 x per year	
Availability 	Business hours (Mon – Fri, 7 a.m. – 5 p.m.)	5 x 24 hrs. (Mon – Fri)		7 x 24 hrs. (Mon – Sun)
On-site service 	Next working day (Mon – Fri, 7 a.m. – 5 p.m.)	Next week day (Mon – Sat, 7 a.m. – 5 p.m.)	Within 8 hours	Within 4 hours*
Warranty extension 	+12/+24/+36 months, includes defined spare parts and repairs		+12/+24/+36 months, includes defined spare parts and repairs, and the preventive replacement of parts	
Stocking of spare parts 	At Rittal	At Rittal and delivered within 24 hours		Based on specific agreement
Inspection 	1 x per year	4 x per year		12 x per year
Leak checks for refrigeration systems 	1 x per year from 5 t CO ₂ equivalent	2 x per year from 50 t CO ₂ equivalent		4 x per year from 500 t CO ₂ equivalent

* Only on request

High-performance cooling



The benefits

- Reduced noise levels and electrical power consumption, thanks to the flexible use of continually regulating EC fan modules
- Tool-free fan replacement with the plug & play system
- Because the electrical assembly pulls out forwards, maintenance from above is unnecessary
- LCP CW glycol variants:
 - Improved thermal recovery thanks to high water return temperatures
 - High cooling output even with the water/glycol mixture

Technology

- Integral Delta T control at the water end for simple setting of the individual Delta T
- High fail-safeness – Maximum cooling output even in emergency situations
- High-performance heat exchangers guarantee maximum cooling output in a small space

New type of condensate management

- High condensate removal with a new type of spray eliminator (patent pending)
- Optimum condensate management, making it ideal for use in areas with high humidity, or for use with low water inlet temperatures

**For further information
on high-performance cooling,
please visit our IT website at
www.rittal.com/it-solutions/en**



Liquid Cooling Package



Accessories for IT cooling Page 40 Chillers for IT cooling Page 56 Network/server enclosures TS IT Cat. 35, page 104

Benefits:

- Maximum energy efficiency due to EC fan technology and IT-based control
- Minimal pressure loss at the air end, which in turn minimises the power consumption of the fans
- Control of the server inlet temperature
- With redundant temperature sensor integrated at the air end as standard
- Optimum adaptability due to dynamic, continuous control of the cold water volume flow
- By using high water inlet temperatures, the proportion of indirect free cooling is increased, which in turn reduces operating costs
- Targeted cooling output due to modular fan units
- Fan modules configurable as n+1 redundancy
- Standard 3-phase connection for electrical redundancy

- The separation of cooling and enclosure prevents the ingress of water into the server enclosure
- Up to 53 kW cooling output on a footprint of just 0.36 m²
- Ideal in conjunction with a heat pump, as the LCP CW glycol variants generate high water return temperatures
- Improved heat recovery, thanks to high water return temperatures when using LCP CW glycol variants
- Optimum access for maintenance and servicing from the front and rear
- Tool-free replacement of the fan modules

Functions:

- The LCP draws in the air at the sides at the rear of the server enclosures, cools it using high-performance compact impellers, and blows the cooled air back into the front part of the server enclosure at the sides

IT monitoring:

- Monitoring of all system-relevant parameters such as server air intake temperature, server waste air temperature, water inlet/return temperature, water flow, cooling output, fan speed, leakage
- Direct connection of the unit via SNMP over Ethernet
- Integration into RiZone

Temperature control:

- Linear fan control
- Two-way control valve

Colour:

- RAL 7035

Protection category IP to IEC 60 529:

- IP 20

Optional:

- Fully integrated fire detection and extinguisher system
- Automatic server enclosure door opening
- Direct connection of additional CMC III sensors is supported
- Racks 2200 mm high

Photo shows a configuration example with equipment not included in the scope of supply

Liquid Cooling Package

LCP Rack CW

Model No.	Packs of	3312.130	3312.230	3312.250	3312.260	Page
Total cooling output/Number of fan modules required kW		10 / 1 20 / 2 30 / 3	10 / 1 20 / 2 30 / 3	30 / 4 32 / 5 35 / 6	48 / 4 51 / 5 53 / 6	
Number of fan modules in supplied state		1	1	4	4	
Width mm		300	300	300	300	
Height mm		2000	2000	2000	2000	
Depth mm		1000	1200	1200	1200	
Type of electrical connection		Connector	Connector	Connector	Connector	
Installation in bayed enclosure suite		Flush	Flush	Flush	Flush	
Rated operating voltage V, ~, Hz		230, 1~, 50/60 400, 3~, 50/60	230, 1~, 50/60 400, 3~, 50/60	230, 1~, 50/60 400, 3~, 50/60	230, 1~, 50/60 400, 3~, 50/60	
Air throughput at max. cooling output m ³ /h		4800	4800	4800	8000	
Fans may be exchanged with the system operational		■	■	■	■	
EC fan		■	■	■	■	
Optimised condensate management, even at low water inlet temperatures		-	-	■	-	
Cooling medium		Water	Water	Water/glycol	Water	
Water inlet temperature °C		15	15	15	15	
Permissible operating pressure (p. max.) bar		10	10	10	10	
Duty cycle %		100	100	100	100	
Water connection		DN 40 (G 1½" external thread)	DN 40 (G 1½" external thread)	DN 40 (G 1½" external thread)	DN 40 (G 1½" external thread)	
Weight as delivered kg		260.0	260.0	280.0	260.0	
Accessories						
Fan module	1 pc(s).	3312.016	3312.016	3312.016	3312.016	43
Touchscreen display, colour	1 pc(s).	3311.030	3311.030	3311.030	3311.030	40
Connection hose	2 pc(s).	3311.040	3311.040	3311.040	3311.040	41
Condensate pump	1 pc(s).	-	-	3312.012	-	42

Selectors



IT infrastructure selector

www.rittal.com/it-selector

Liquid Cooling Package



Accessories for IT cooling Page 40 Chillers for IT cooling Page 56 Network/server enclosures TS IT Cat. 35, page 104 Aisle containment Page 48

Benefits:

- Maximum energy efficiency due to EC fan technology and IT-based control
- Minimal pressure loss at the air end, which in turn minimises the power consumption of the fans
- Optimum adaptability due to dynamic, continuous control of the cold water volume flow
- By using high water inlet temperatures, the proportion of indirect free cooling is increased, which in turn reduces operating costs
- Targeted cooling output due to modular fan units
- Fan modules configurable as n+1 redundancy

- Standard 3-phase connection for electrical redundancy
- With redundant temperature sensor integrated at the air end as standard
- The separation of cooling and enclosure prevents the ingress of water into the server enclosure
- Up to 53 kW cooling output on a footprint of just 0.36 m²
- Ideal in conjunction with a heat pump, as the LCP CW glycol variants generate high water return temperatures
- Improved heat recovery, thanks to high water return temperatures when using LCP CW glycol variants

- Optimum access for maintenance and servicing from the front and rear
- Tool-free replacement of the fan modules

Functions:

- The hot air is drawn in from the room or hot aisle at the rear of the device and expelled at the front into the cold aisle after cooling. With this product, a raised floor is not necessary

IT monitoring:

- Monitoring of all system-relevant parameters such as server air intake temperature, server waste air temperature, water inlet/return temperature, water flow, cooling output, fan speed, leakage

- Direct connection of the unit via SNMP over Ethernet
- Integration into RiZone

Temperature control:

- Linear fan control
- Two-way control valve

Colour:

- RAL 7035

Protection category IP to IEC 60 529:

- IP 20

Optional:

- Direct connection of additional CMC III sensors is supported
- Racks 2200 mm high

Photo shows a configuration example with equipment not included in the scope of supply

Liquid Cooling Package

LCP Inline CW

Model No.	Packs of	3312.530	3312.540	3312.550	3312.560	3312.570	Page
Total cooling output/Number of fan modules required kW		10 / 1 20 / 2 30 / 3	18 / 2 27 / 3 30 / 4	16 / 2 25 / 3 28 / 4	48 / 4 51 / 5 53 / 6	30 / 4 32 / 5 35 / 6	
Number of fan modules in supplied state		1	2	2	4	4	
Width mm		300	300	300	300	300	
Height mm		2000	2000	2000	2000	2000	
Depth mm		1200	1200	1200	1200	1200	
Type of electrical connection		Connector	Connector	Connector	Connector	Connector	
Installation in bayed enclosure suite		Set forward	Flush	Flush	Set forward	Set forward	
Rated operating voltage V, ~, Hz		230, 1~, 50/60 400, 3~, 50/60	230, 1~, 50/60 400, 3~, 50/60	230, 1~, 50/60 400, 3~, 50/60	230, 1~, 50/60 400, 3~, 50/60	230, 1~, 50/60 400, 3~, 50/60	
Air throughput at max. cooling output m ³ /h		4800	5000	5000	8000	4800	
Fans may be exchanged with the system operational		■	■	■	■	■	
EC fan		■	■	■	■	■	
Optimised condensate management, even at low water inlet temperatures		-	-	■	-	■	
Cooling medium		Water	Water	Water/glycol	Water	Water/glycol	
Water inlet temperature °C		15	15	15	15	15	
Permissible operating pressure (p. max.) bar		10	10	10	10	10	
Duty cycle %		100	100	100	100	100	
Water connection		DN 40 (G 1½" external thread)	DN 40 (G 1½" external thread)	DN 40 (G 1½" external thread)	DN 40 (G 1½" external thread)	DN 40 (G 1½" external thread)	
Weight as delivered kg		260.0	260.0	280.0	260.0	280.0	
Accessories							
Fan module	1 pc(s).	3312.016	3312.016	3312.016	3312.016	3312.016	43
Touchscreen display, colour	1 pc(s).	3311.030	3311.030	3311.030	3311.030	3311.030	40
Connection hose	2 pc(s).	3311.040	3311.040	3311.040	3311.040	3311.040	41
Rear adaptor	1 pc(s).	3311.080	-	-	3311.080	3311.080	41
Condensate pump	1 pc(s).	-	-	3312.012	-	3312.012	42

Security Solutions



IT security rooms

www.rittal.com/it-security-rooms



IT cooling

Accessories



Refrigerant lines

for LCU DX

For connecting the internal and external unit of the LCU DX. Consisting of intake gas line and liquid line. The refrigerant lines are insulated.

Design	Length m	Product-specific scope of supply	Packs of	Model No.
LCU DX 3 kW	20	Intake gas line 1/2" Liquid line 1/4"	1 pc(s).	3311.495
LCU DX 6.5 kW	20	Intake gas line 5/8" Liquid line 3/8"	1 pc(s).	3311.496



Touchscreen display, colour

for LCP Rack/Inline CW

The display offers the opportunity of directly monitoring key functions of the LCP, and implementing settings.

Supply includes:

- Assembly parts

Packs of	Model No.
1 pc(s).	3311.030

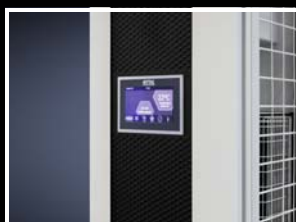

Condenser unit

for LCP DX

The condenser units are necessary for operating refrigerant-based LCPs. Depending on the version, the units have an external condenser and fan, or additionally a free cooler. The variant with free cooler is needed for the combination variant LCP DX/FC. The units are suitable for roof and wall mounting.

Supply includes:

- Assembly parts



W x H x D mm	Design	Temperature control	No. of fans	Rated operating voltage V, ~, Hz	Cooling medium	Refrigerant	Weight kg	Packs of	Model No.
1303 x 578 x 510	Condenser	Speed-controlled fan	2	230, 1~, 50/60	–	R410a	34.0	1 pc(s).	3311.360
2282 x 480 x 510	Condenser	Speed-controlled fan	3	230, 1~, 50/60	–	R410a	48.0	1 pc(s).	3311.363
2393 x 1270 x 1110	Condenser	Speed-controlled fan	2	230, 1~, 50/60	–	R410a	170.0	1 pc(s).	3311.370
3047 x 1270 x 1111	Condenser with free cooler	Speed-controlled fan	2	230, 1~, 50/60	Water/glycol	R410a	285.0	1 pc(s).	3311.380

SNMP card

For connecting LCP Rack/Inline DX units to the network. The SNMP card is plugged into the control board of the LCP and is ready to use. Software configuration is subsequently carried out via the Web interface.

Functions:

- Automatic alarm messages by e-mail or SNMP trap when a limit value is exceeded
- Remote modification of the device setpoint

Supply includes:

- SNMP card
- RJ 45 coupling
- CAT 6 cable STP

Protocols	Packs of	Model No.
SNMPv1 Modbus/TCP	1 pc(s).	3311.320

[Accessories for LCP CW/DX:SNMP card](#)
[SNMP card:Accessories for LCP CW/DX](#)



Vertical shielding

for TS IT

To block the airflow on the left and right of the 482.6 mm (19") level, for enclosure height 2000 mm.

Design:

- Self-adhesive on one side

Material:

- Cellular PU foam
- Flame-inhibiting to UL 94 (HF1)

[Accessories for LCP CW/DX:Shielding, vertical](#)
[Shielding, vertical](#)

Sealing between	W x H x D mm	For enclosure width mm	Packs of	Model No.
LCP and 482.6 mm (19") level	210 x 1915 x 110	800	1 pc(s).	3301.320
LCP and 482.6 mm (19") level	110 x 1915 x 110	600	1 pc(s).	3301.370
Side panel and 482.6 mm (19") level	84 x 1910 x 84	600	1 pc(s).	3301.380
Side panel and 482.6 mm (19") level	184 x 1910 x 84	800	1 pc(s).	3301.390



Connection hose

for LCP Rack/Inline CW

Flexible connection hose at the bottom or top, may be cut to required length, including union nuts on both ends for connecting the LCP to existing pipe-work.

Length m	Water connections	Packs of	Model No.
1.8	1½"	2 pc(s).	3311.040

[Accessories for LCP CW/DX:Connection hose](#)
[Liquid Cooling Package:Accessories for LCP CW/DX](#)



Rear adaptor

for LCP Inline CW

May be positioned to the rear of the set forward LCP Inline CW to close the existing gap to the rear section.

Supply includes:

- Adaptor
- With roof plate
- Assembly parts

Packs of	Model No.
1 pc(s).	3311.080

[Accessories for LCP CW/DX:Rear adaptor for LCP Inline CW](#)
[Liquid Cooling Package:Accessories for LCP CW/DX](#)

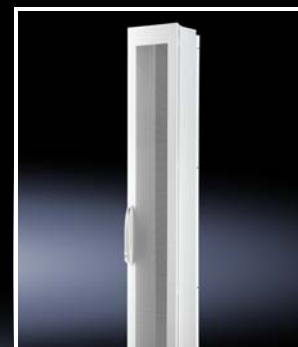

IT cooling

Accessories



Filter mat holder

for LCP Inline CW

The filter mat holder is comprised of a metal frame, into which the open-pore filter mat is inserted. The filter mat is fixed in the frame with additional metal brackets. The filter mat holder itself is secured in the perforated rear door of the LCP Inline CW using magnets.

Supply includes:

- Filter mat holder
- Filter mat
- Assembly parts

Filter class to DIN EN 779	Packs of	Model No.
G1	1 pc(s).	3311.042



Accessories:

- Filter mat, see page 4242
- [Filter mat holder:for LCP Inline CW](#)
[Accessories for LCP CW/DX:Filter mat holder](#)

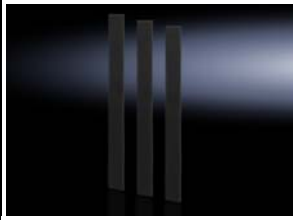

Filter mat

for LCP Inline CW

Matching, open-pore spare filter mat for the filter mat holder in the LCP Inline CW.

Colour:

- Dark grey

Filter class to DIN EN 779	Packs of	Model No.
G1	3 pc(s).	3311.043

- [Filter mat holder:for LCP Inline CW](#)
[Accessories for LCP CW/DX:Filter mat holder](#)

Condensate pump

for LCP Rack/Inline CW

For discharging condensate with LCP Rack/Inline CW applications.

Benefits:

- Plug & play installation in all LCP Rack/Inline CW variants

Supply includes:

- Condensate pump
- Condensate hose
- Condensate sensor
- Connection cable
- Assembly parts

Packs of	Model No.
1 pc(s).	3312.012

- [Condensate pump:for LCP Rack/Inline CW](#)
[Accessories for LCP CW/DX:Condensate pump](#)

Fan module

for LCP Rack/Inline CW

To increase the cooling output, individual fan modules may be retro-fitted into the LCPs. Additional integration can also achieve redundancy and reduce the electrical power consumption of the LCP.

Packs of	Model No.
1 pc(s).	3312.016

[Accessories for IT cooling: Fan module](#)
[Fan module: for LCP Rack/Inline CW](#)

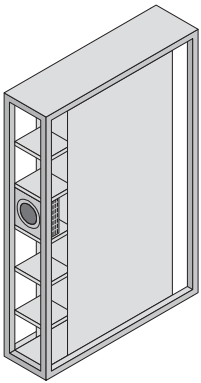

The LCP 3312.130/.230/.530 (max. 30 kW) is supplied with one fan module as standard.

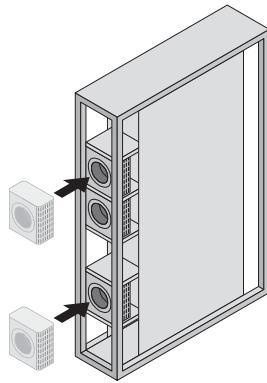

To achieve the max. cooling output, the customer/service should install two additional fan modules.

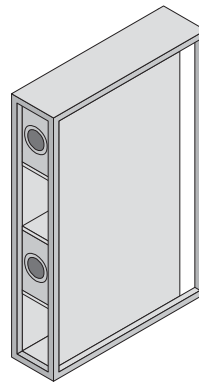

The LCP 3312.540/.550 (max. 30/28 kW) is supplied with two fan modules as standard.

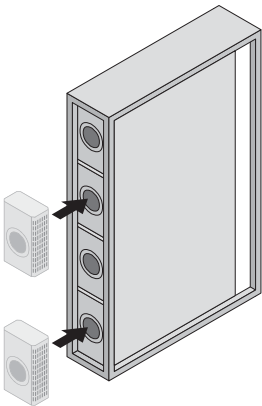

To achieve the max. cooling output, the customer/service should install two additional fan modules.

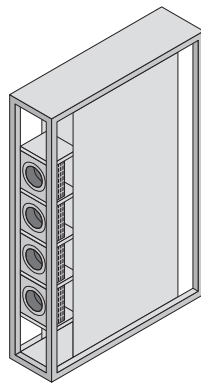

The LCP 3312.250/.260/.560/.570 (max. 40/53/53/35 kW) is supplied with four fan modules as standard.

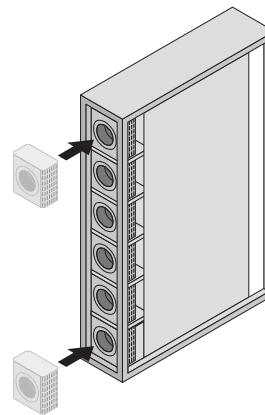

To achieve the max. cooling output, the customer/service should install two additional fan modules.

Note:

- The max. cooling output for the relevant LCP variants can be found in the order tables from page 36

IT cooling

Accessories



Air baffle plates for TS IT 482.6 mm (19") mounting angles

With all-round brush strip for collision-free shielding with installed bar systems on the outer mounting level.

Applications:

- To separate the hot/cold zones within an enclosure with aisle containment or when using an LCP system.

Material:

- Sheet steel
- Blanking panel: Plastic, UL 94-HB, halogen-free
- Brush strip: Plastic, UL 94-HB

Surface finish:

- Spray-finished

Colour:

- RAL 9005

Supply includes:

- 2 vertical trim panels
- 2 horizontal trim panels
- 4 brush strips
- 4 cellular PU foam pieces
- Assembly parts

For enclosure width mm	For enclosure height mm	Product-specific scope of supply	Packs of	Model No.
600	2000	-	1 pc(s).	5501.805
800	2000	6 blanking panels, 1 U	1 pc(s).	5501.815
600	2200	-	1 pc(s).	5501.825
800	2200	6 blanking panels, 1 U	1 pc(s).	5501.835

Assembly instruction:

- The vertical trim panels with brush strip may be fitted on both the front and rear 482.6 mm (19") mounting angles for partitioning.
- The horizontal trim panels with brush strips can only be mounted on the front 482.6 mm (19") mounting angles.

[Air baffle plates:for TS IT 482.6 mm \(19"\) mounting angles](#)



Air baffle plates for TS IT 482.6 mm (19") mounting frames

With all-round brush strip for collision-free shielding with installed rail systems on the outer mounting level.

Applications:

- To separate the hot/cold zones within an enclosure with aisle containment or when using an LCP system.

Material:

- Sheet steel
- Blanking panel: Plastic, UL 94-HB, halogen-free
- Brush strip: Plastic, UL 94-HB

Surface finish:

- Spray-finished

Colour:

- RAL 9005

Supply includes:

- 2 vertical trim panels
- 2 horizontal trim panels
- 4 brush strips
- Assembly parts

For enclosure width mm	For enclosure height mm	Product-specific scope of supply	Packs of	Model No.
600	1200	-	1 pc(s).	5501.855
800	1200	1 blanking panel, 3 U	1 pc(s).	5501.865
600	1800	-	1 pc(s).	5501.875
800	1800	2 blanking panels, 3 U	1 pc(s).	5501.885
600	2000	-	1 pc(s).	5501.905
800	2000	2 blanking panels, 3 U	1 pc(s).	5501.915
600	2200	-	1 pc(s).	5501.925
800	2200	2 blanking panels, 3 U	1 pc(s).	5501.935

Assembly instruction:

- The vertical and horizontal trim panels with brush strip may be fitted on both the front and rear 482.6 mm (19") mounting frame for partitioning.

[Air baffle plates:for TS IT 482.6 mm \(19"\) mounting frames](#)

482.6 mm (19") air duct

for horizontal air routing

Air duct, passive, for cold air supply to 482.6 mm (19") IT equipment installed at the rear of server racks; air is drawn in from the front.

Benefits:

- For superior air infeed to the rear 482.6 mm (19") components
- Integral brush strip for cable entry of 482.6 mm (19") IT equipment
- Supports front-to-back air routing
- Depth-variable

Material:

- Sheet steel, spray-finished
- Brush strip: Plastic, UL 94-HB

Colour:

- RAL 9005

Width mm	Height U	Depth mm	Packs of	Model No.
482.6	1	223 - 356	1 pc(s).	3301.391

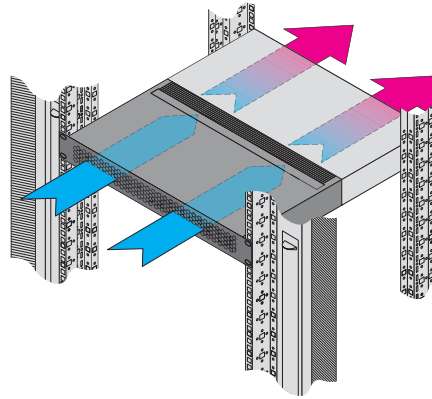

Air duct:for 482.6 mm (19") mounting level
Air routing:horizontal air routing

Air duct

for side air routing

Air duct, passive, for cold air intake to 482.6 mm (19") equipment with side air inlet.

Benefits:

- For superior air infeed to the rear 482.6 mm (19") equipment with side air routing
- Integral membrane cover allows cable entry to the rear
- Depth-variable

Installation options:

- for TS IT 482.6 mm (19") mounting angles
- for TS IT 482.6 mm (19") mounting frames

Material:

- Sheet steel, spray-finished

Colour:

- RAL 9005

Supply includes:

- Adaptor for attaching to 482.6 mm (19") mounting angles
- Magnetic strip to cover the remaining vertical openings in the air baffle plate



Also required:

- Air baffle plates for TS IT 482.6 mm (19") mounting frames, see page 44
- Air baffle plates for TS IT 482.6 mm (19") mounting angles, see page 44



Assembly instruction:

- Only suitable for fitting on the front 482.6 mm (19") installation level
- Can only be mounted in the area of the vertical 19° openings of the air baffle plate

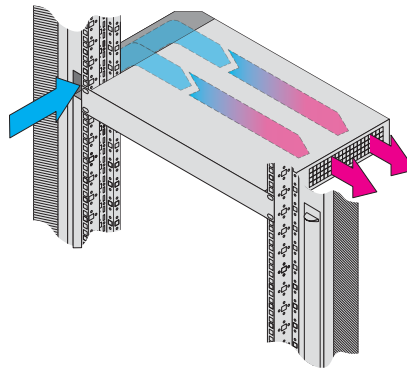

Air duct
Air routing:side air routing

Height U	Depth mm	For enclosure width mm	Packs of	Model No.
2	275 - 418	800	1 pc(s).	3301.392

IT cooling

Accessories



Cover, magnetic

For optionally covering the front system punchings in the event of complete air blocking of the front, or in the absence of installed cable fingers or dynamic rack control strip. With numerical labelling on an imperial pitch pattern for clear identification of the various height units. The double-sided labelling allows the counting direction to be freely selected from 1 – 47 U.

Material:

- Cover: PVC
- Adhesive measurement strips: Plastic

Supply includes:

- 1 cover (front)
- 2 adhesive measurement strips, self-adhesive, 1-47 U (bi-directional)

Length m	Packs of	Model No.
5	1 pc(s).	5501.895

[Cover:magnetic](#)

Blanking panel, 3 U

Tool-free attachment, 482.6 mm (19")

The blanking panel is used to seal unused areas within the 482.6 mm (19") mounting level. Quick tool-free attachment means that it is easily integrated anywhere, and can also be removed again if necessary. The consistent use of blanking panels ensures targeted air routing in partially populated racks.

Benefits:

- May be adjusted individually to size by snapping off prepunched 1 U elements
- Each individual element is self-supporting and may therefore be combined into larger units in conjunction with other elements

Material:

- Plastic
- Fire protection: Self-extinguishing, to UL 94 HB, halogen-free

Colour:

- RAL 9005

Supply includes:

- Blanking panel, 3 U, with integral quick-fastening

Installation height U	Width mm	Packs of	Model No.
3	482.6	3 pc(s).	7151.305

[Cover:Tool-free attachment, 482.6 mm \(19"\)](#)

[Cover:Blanking panel, 482.6 mm \(19"\)](#)

[Blanking plates, 482.6 mm \(19"\):3 U](#)

[Blanking panel:Tool-free attachment, 482.6 mm \(19"\)](#)

Roof-mounted cooling units



Accessories for IT cooling Page 40

Applications:

- Cooling of IT equipment in IT enclosures sited as stand-alone units in secondary rooms

Benefits:

- Even air distribution in front of the 482.6 mm (19") level

Functions:

- The device supports front-to-back air routing typical of IT applications, and regulates the server inlet temperature to the set value

- The hot waste air from the IT equipment is drawn into the device at the rear of the IT enclosure, cooled, and the cooled air blown back in front of the 482.6 mm (19") level

IT monitoring:

- Monitoring of incoming air temperature

Temperature control:

- Control of the server inlet temperature

Material:

- Sheet steel

Colour:

- RAL 7035

Protection category IP to IEC 60 529:

- External circuit IP 20
- Internal circuit IP 20

Supply includes:

- Nano-coated condenser
- Integral electric condensate evaporation
- Fully wired ready for connection
- Drilling template
- Air baffle plate
- Assembly parts

for cooling IT equipment

Model No.	Packs of	3301.800	Page
Total cooling output L25 L35 W		3000	
Total cooling output L35 L45 W		3200	
Width mm		597	
Height mm		417	
Depth mm		895	
Type of electrical connection		Plug-in terminal strip	
Rated operating voltage V, ~, Hz		230, 1~, 50	
Start-up current max. A		36	
Pre-fuse (T) A		16	
Rated current max. A		10.4	
Refrigerant g		R134a, 1200	
Permissible operating pressure (p. max.) bar		25	
Duty cycle %		100	
Operating temperature range		+20°C...+45°C	
Setting range		+20°C...+25°C	
Weight as delivered kg		97.0	
Also required			
Roof plates		see page	50
Accessories			
Condensate hose	1 pc(s).	3301.612	Cat. 35, 464
Door-operated switch	1 pc(s).	4127.010	Cat. 35, 755
Air baffle plates for TS IT 482.6 mm (19") mounting angles		see page	44
Filter mats	3 pc(s).	3286.500	Cat. 35, 454

Consistently separate!

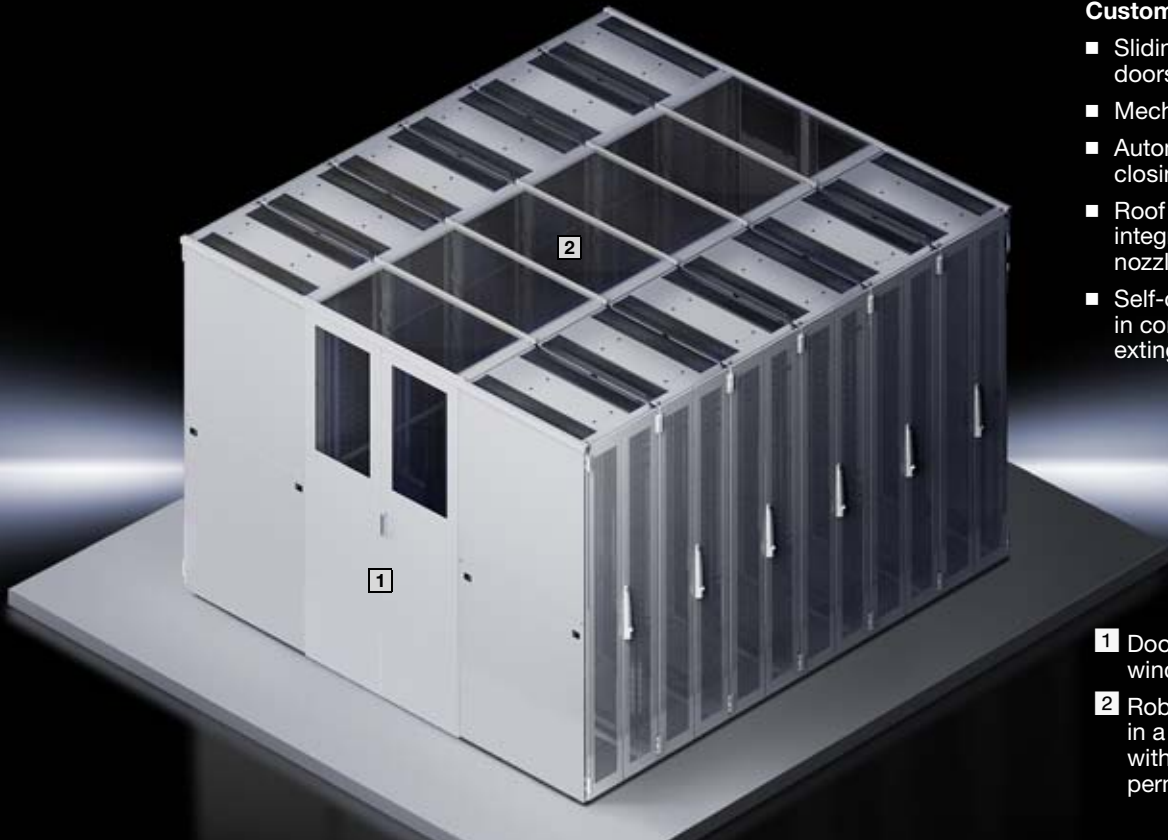

Customised options

- Sliding doors or swing doors
- Mechanical door lock
- Automatic door opening/closing via motor
- Roof elements for the integration of extinguisher nozzles
- Self-opening roof elements in combination with room extinguisher

1 Door element with viewing window and sliding door

2 Robust roof elements in a composite material with a high level of light permeability

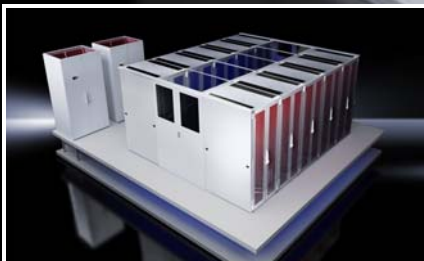

Cold aisle with raised floor

CRAC systems supply cooled air into the cold aisle via the perforated panels of the raised floor.

- Even with low room heights, the raised floor height is maximised for cooling air supply without flow losses
- Undisturbed supply and uniform distribution of cooling air in the cold aisle guarantees high efficiency
- Hardware racks not connected to the enclosure do not impair cooling efficiency via the cold aisle

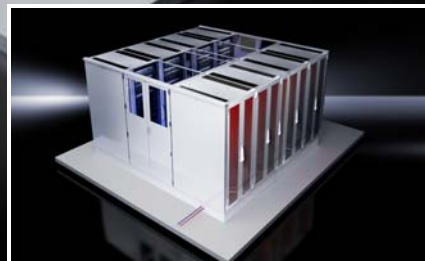

Cold aisle without raised floor

The LCP Inline routes the cooled air directly to the cold aisle at the front.

- Simple routing of the piping in the base/plinth
- Homogeneous distribution of cooling air in the cold aisle guarantees a high level of efficiency
- Hardware racks not connected to the containment system do not impair cooling efficiency via the cold aisle
- Room heights play only a minimal role

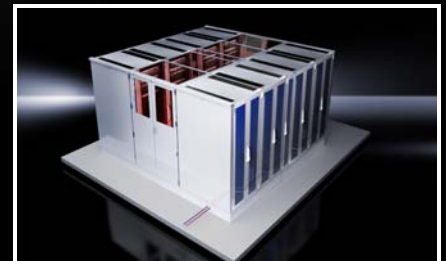

Hot aisle without raised floor

The LCP Inline extracts the hot air directly at the point where it is created. The cooling performance of the cooling units is utilised to optimum effect, and the overall efficiency of the system increases significantly.

- Simple routing of the piping in the base/plinth
- Suitable for use with high heat losses
- Room-neutral dissipation of the heat loss

Aisle containment



Liquid Cooling Package Page 30 **Network/server enclosures TS IT** Cat. 35, page 104

Slimline door element with viewing window and sliding door. Stable roof elements in a composite material with a high level of light permeability. Where required, safety glass may also be used. The aisle width is 1,200 mm.

Applications:

- Depending on the application, aisle containment may be used with CRAC systems or LCP Inline as hot or cold aisle containment.

Benefits:

- Increased energy efficiency and performance capability of climate control.
- Easily installed and retrofitted, as it is fully compatible with the TS IT enclosure system.
- An inexpensive way to boost the performance of your existing installation, lengthening the investment cycle until a replacement needs to be purchased.

Functions:

- Aisle containment is a combination of door and roof components which facilitate consistent separation of the hot and cold air in the data centre. Such separation is pivotal to saving energy and increasing the efficiency of the available climate control technology.

Colour:

- RAL 7035

Photo shows a configuration example with equipment not included in the scope of supply

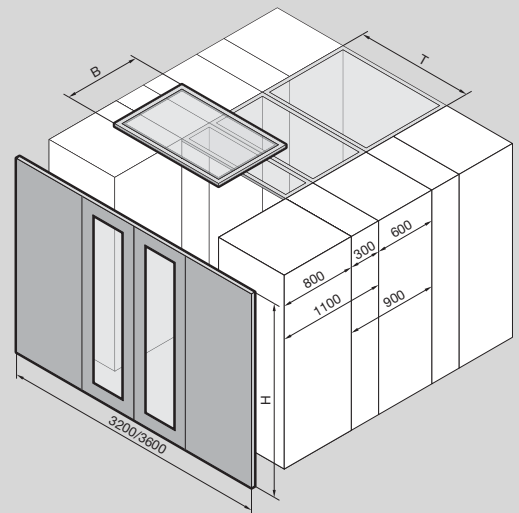

Design	Packs of	Door element	Door element	Roof element centre	Roof element centre	Roof element centre	Roof element centre	Roof element centre	Roof element start/end	Roof element start/end
Model No.	1 pc(s).	3311.161	3311.163	3311.170	3311.180	3311.190	3311.200	3311.210	3311.270	3311.280
For enclosure depth mm		1000	1200	–	–	–	–	–	–	–
Width (B) mm		3200	3600	600	800	300	900	1100	600	800
Height (H) mm		2000	2000	–	–	–	–	–	–	–
Depth (T) mm		–	–	1200	1200	1200	1200	1200	1200	1200
Weight as delivered kg		120.0	150.0	30.0	35.0	20.0	30.0	33.0	30.0	28.0

Small cooling units

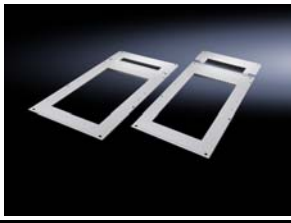

Roof plates

for TS IT

Roof plate with matching cut-out for the roof-mounted cooling unit for cooling IT equipment

Applications:

- Roof-mounted cooling units

Material:

- Sheet steel

Supply includes:

- Roof plate, 1000 mm
- Including brush strip to extend to 1200 mm
- Seal
- Assembly parts

To fit Model No.	Width mm	For enclosure depth mm	Packs of	Model No.
SK 3301.800	600	1000 1200	1 pc(s).	3302.860
SK 3301.800	800	1000 1200	1 pc(s).	3302.880



Assembly instruction:

- Only possible in conjunction with TS IT with mounting angles.



Roof-mounted fans

for TS, TS IT, for the office sector

This roof ventilation concept offers a wealth of performance, assembly and cost benefits associated with the use of integrated ventilation systems. This roof-mounted fan may be ordered with and without a roof plate. For the version with roof plate, the roof-mounted fan is pre-installed. This roof plate also has an integral rear cable entry via a sliding plate with rubber cable clamp strip. Another outstanding feature is the enormous volumetric flow combined with exceptionally low noise levels, making it ideal for use in sensitive office areas.

Benefits:

- Easy assembly, the roof plate variant eliminates the need to create mounting cut-outs
- Fully wired ready for connection

Colour:

- RAL 7035

Supply includes:

- Roof-mounted fans
- Assembly parts

Note:

- Reduction in the specified air throughput to 800 m³/h at 40 Pa counterpressure using two vented base/plinth trim panels

Model No.	3164.230	3164.620
Packs of	1 pc(s).	1 pc(s).
Rated operating voltage V, ~, Hz	230, 1~, 50/60	230, 1~, 50/60
Air throughput, unimpeded air flow m ³ /h	1500	1500
Design	without roof plate	With roof plate
Rated current A	0.3 / 0.35	0.3 / 0.35
Power consumption W	68 / 81	68 / 81
Width mm	511	800
Height mm	227	240
Depth mm	511	800
Required mounting cut-out mm	410 x 410	-
Fan	Radial	Radial
Operating temperature range	+20°C...+55°C	+20°C...+55°C
Noise level dB(A)	40	40
Weight kg	19.5	30.0



Accessories:

- Digital enclosure internal temperature display and thermostat integrated into a patch panel 1 U, see Cat. 35, page 466
- Digital enclosure internal temperature display and thermostat, see Cat. 35, page 466
- Thermostat, see Cat. 35, page 467
- Thermostat with strain relief, see Cat. 35, page 467

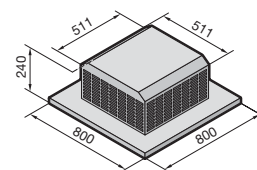
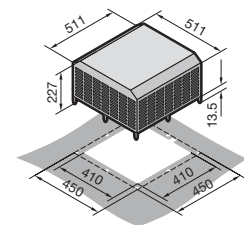

Small cooling units

Fan mounting plate

for TS IT, TE

For active ventilation. The unit may optionally be extended with additional fans.

Applications:

- For use in the cut-out integrated into the roof plate.

Colour:

- RAL 7035

Supply includes:

- 1 fan unit
- 2 fans
- 1 thermostat
- Connection cable, open-ended
- Assembly parts

Note:

- The noise level given refers to the first fan.
- Connection via distributor box or country-specific connector.



Accessories:

- Fan expansion kit, see page 53
- [Fan mounting plate:for TS IT, TE](#)

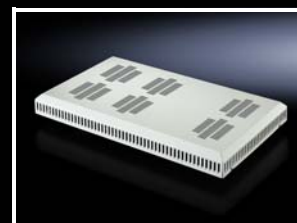

W x H x D mm	Installation options	No. of fans	Number of fans (max.)	Air through-put per fan m ³ /h	Output per fan W	Rated operating voltage V, ~, Hz	Operating temperature range	Noise level per fan dB(A)	Packs of	Model No.
200 x 59 x 550	In the TS IT with W x D: 600 x 1000 / 600 x 1200 / 800 x 600	2	3	160 / 180	15 / 14	230, 1~, 50/60	+5°C ...+55°C	37	1 pc(s).	5502.010
340 x 54 x 550	In the TS IT with W x D: 800 x 800 / 800 x 1000 / 800 x 1200 In the TE 8000 with W x D: 600 x 600 / 600 x 800 / 600 x 1000 / 800 x 600 / 800 x 800 / 800 x 1000	2	6	160 / 180	15 / 14	230, 1~, 50/60	+5°C ...+55°C	37	1 pc(s).	5502.020

Small cooling units



Fan mounting plate

For upgrading existing DK-TS applications. The plate is mounted at the front of the enclosure, whilst the rear section is left free for cable entry. A rubber cable clamp strip is supplied loose for optional sealing at the rear.

Installation options:

- In a solid roof plate raised with 20 or 50 mm roof spacers
- In a roof plate for cable entry raised with 20 or 50 mm roof spacers
- In a vented roof plate for cable entry

Colour:

- RAL 7035

Supply includes:

- Fan mounting plate including 2 fans and additional cut-outs for more fans
- 1 thermostat
- Self-adhesive foam cable clamp strip
- Thermostat and fan fully wired to connection cable (3.5 m).

Note:

- Not suitable for crane transportation
- In combination with the swing frame, large, or roof plate for cable entry at the rear, the fan mounting plate should be selected as follows:
Fan mounting plate = enclosure depth - 200 mm
- Not suitable in combination with 482.6 mm (19") mounting frame
- The air throughput can be increased with fan expansion kit 7980.000.
- The noise level given refers to the first fan.

Assembly instruction:

- Self-adhesive foam cable clamp strip 2573.000 is required for sealing the sides and for targeted air routing when bayed

Accessories:

- Fan expansion kit, see page 53

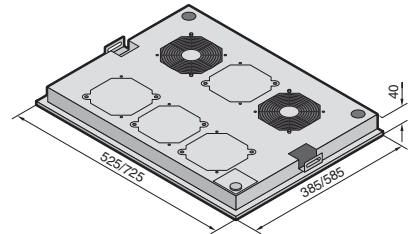

Fan mounting plate

To fit enclosure width/depth mm	No. of fans	Number of fans (max.)	Air throughput per fan m ³ /h	Output per fan W	Rated operating voltage V, ~, Hz	Operating temperature range	Noise level per fan dB(A)	Packs of	Model No.
600 x 600	2	4	160 / 180	15 / 14	230, 1~, 50/60	+5°C ...+55°C	37	1 pc(s).	7966.035
600 x 800 600 x 1000 600 x 1200	2	6	160 / 180	15 / 14	230, 1~, 50/60	+5°C ...+55°C	37	1 pc(s).	7968.035
800 x 600	2	6	160 / 180	15 / 14	230, 1~, 50/60	+5°C ...+55°C	37	1 pc(s).	7986.035
800 x 800 800 x 1000 800 x 1200	2	6	160 / 180	15 / 14	230, 1~, 50/60	+5°C ...+55°C	37	1 pc(s).	7988.035

Fan expansion kit

For use as a stand-alone fan, and for upgrading various fan units or to supplement the fan mounting plate.

Supply includes:

- Fan
- Connection cable (0.61 m)
- Assembly parts

[Fan expansion kit](#)



W x H x D mm	Air throughput (unimpeded air flow) m³/h	Rated operating voltage V, ~, Hz	Power consumption W	Operating temperature range	Noise level dB(A)	Packs of	Model No.
119 x 119 x 38	160 / 180	230, 1~, 50/60	15 / 14	-10°C...+55°C	37 / 37	1 pc(s).	7980.000
119 x 119 x 25	108 / 120	230, 1~, 50/60	14 / 12	-20°C...+70°C	34 / 34	1 pc(s).	7980.100
119 x 119 x 38	184	48 (DC)	7.7	-20°C...+70°C	43	1 pc(s).	7980.148

Vent cover

for TS, TS IT

The ideal addition for incorporating sealed racks into an existing central climate control system. The stepped connection is suitable for standard pipe diameters, thereby ensuring effective cooling thanks to targeted air exchange inside the rack.

Material:

- PET-G, transparent

Supply includes:

- Assembly parts

[Vent cover](#)

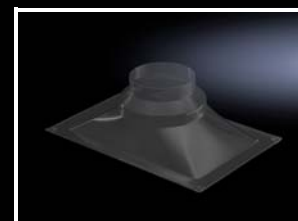

W x H x D mm	Note	Diameter of hose connection mm	Weight kg	Packs of	Model No.
450 x 144 x 300	Required cut-out in the roof plate (W x D): 380 x 230 mm	150/200	0.96	1 pc(s).	7826.750

CRAC – COMPUTER ROOM AIR CONDITIONER

Precision climate control units for data centres



The technology – Simply efficient

Precision climate control units from Rittal ensure optimum climatic conditions in data centres that are exposed to high thermal loads. By precisely regulating the temperature and humidity, these climate control units guarantee optimum ambient conditions for your valuable IT equipment. Waste heat is dissipated according to requirements. Redundant solutions offer a high degree of fail-safeness and energy-efficient use.

CRAC DX precision climate control units for direct evaporation with external air-cooled condenser unit

- Upflow, downflow, displacement
- AC fan or optionally EC fan
- Available with electronic expansion valve, electric heater, steam humidifier, additional heat exchanger for cooling with cold water instead of direct evaporation or internal water-cooled condenser unit
- Complete set of optional accessories: Network protocol cards, filters, plenum space, base frame

CRAC DX precision climate control units for direct evaporation with inverter- controlled compressor and external air-cooled condenser unit

- Upflow, downflow, displacement
- EC fan
- Available with electric heater, steam humidifier, additional heat exchanger for cooling with cold water instead of direct evaporation or internal water-cooled condenser unit
- Complete set of optional accessories: Network protocol cards, filters, plenum space, base frame

CRAC CW precision climate control units for cold water operation

- Upflow, downflow, displacement
- Fans positioned in the device or in the raised floor (downflow only)
- EC fan
- Available with electric heater, steam humidifier
- Complete set of optional accessories: Network protocol cards, filters, plenum space, base frame

Computer Room Air Conditioner

**For further information
on precision climate control units
for data centres,
please visit our IT website at
www.rittal.com/it-solutions/en**

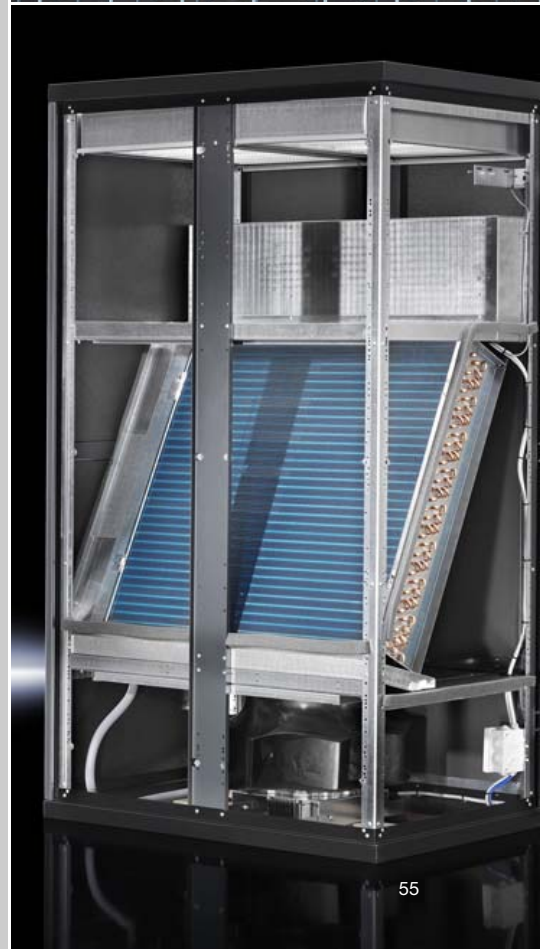
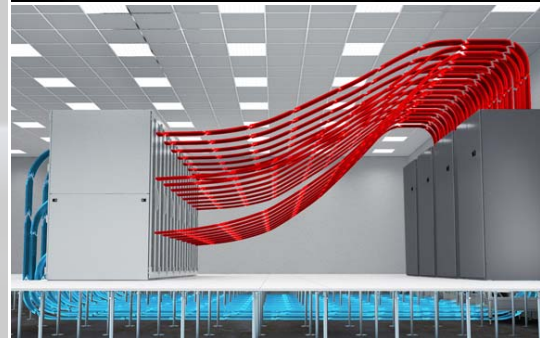

Chillers for IT cooling



Applications:

- Especially for cooling IT applications, such as LCP or CRAC

Benefits:

- Indirect free cooling – internal and external
- High-efficiency pumps in the cold water circuit
- At least two high-performance compressors
- Two independent cooling circuits from 50 kW
- Up to 8 chillers may be linked together to form a cascade

IT monitoring:

- Monitoring of all system-relevant parameters such as server air intake temperature, server waste air temperature, water inlet/return temperature, water flow, cooling output, fan speed, leakage
- Direct connection of the unit via SNMP/Modbus over Ethernet.
- Integration into RiZone

Technical specifications:

- Compact design with control components in the front and air intake via both side panels, air outlet upwards
- Pressure-sealed system
- Integral bypass

Protection category IP to IEC 60 529:

- Electrical components IP 54

Supply includes:

- Chiller wired ready for connection
- Multi-lingual documentation
- Functional diagram and wiring plans

Optional:

- Free cooling may be integrated from 15 kW. Please follow the instructions
- Buffer store for separate siting
- Emergency cooling with mains water infeed
- Cooling outputs > 500 kW

Note:

- Technical deviations in terms of cooling output, dimensions or weight are possible for unit types with free cooling
- The performance data varies according to the option package chosen, and should be taken from the IT chiller configurator. We reserve the right to make technical modifications
- Pump and tank are available as options with IT chillers. If these configuration options are required, their technical data applies

Total cooling output 15 – 67 kW

Model No.	Packs of	3232.701	3232.711	3232.721	3232.731	3232.741
Total cooling output kW		15	24	36	48	67
Width mm		810	810	810	1000	1100
Height mm		1542	1542	1542	1780	1606
Depth mm		1800	1800	1800	2300	3240
Rated operating voltage V, ~, Hz		400, 3~, 50	400, 3~, 50	400, 3~, 50	400, 3~, 50	400, 3~, 50
Air throughput at max. cooling output m ³ /h		10880	10880	14000	18000	22000
Power consumption kW		6.9	9.7	14.6	21	21
Rated current max. A		23	25	37	46.5	52.2
Refrigerant		R407c	R407c	R407c	R407c	R410a
Permissible operating pressure (p. max.) bar		28	28	28	28	45
Operating temperature range		-20°C...+43°C	-20°C...+43°C	-20°C...+43°C	-20°C...+43°C	-20°C...+43°C
Temperature of liquid		+5°C...+15°C	+5°C...+15°C	+5°C...+15°C	+5°C...+15°C	+5°C...+15°C
Pump capacity l/min		60	60	120	120	240
Pump pressure bar		2.5	2.5	2.5	2.5	2.5
Number of cooling circuits		1	1	1	1	2
Steel tank, with 10 mm condensate insulation		■	■	■	■	■
Tank capacity l		48	48	48	100	200
Water connection		G 1½" internal thread	G 1½" internal thread	G 1½" internal thread	G 1½" internal thread	G 2½" internal thread
Weight as delivered kg		400.0	415.0	505.0	710.0	896.0
Operating weight kg		448.0	463.0	553.0	810.0	1096.0
Colour		RAL 7035	RAL 7035	RAL 7035	RAL 7035	RAL 9002

Chillers for IT cooling

Total cooling output 77 – 124 kW

Model No.	Packs of	3232.751	3232.761	3232.771	3232.781	3232.791
Total cooling output kW		77	88	99	117	124
Width mm		1100	1100	1100	1100	1100
Height mm		1606	1606	1606	1875	1875
Depth mm		3240	3240	3240	3240	3240
Rated operating voltage V, ~, Hz		400, 3~, 50	400, 3~, 50	400, 3~, 50	400, 3~, 50	400, 3~, 50
Air throughput at max. cooling output m³/h		22000	27000	27000	34100	34100
Power consumption kW		24	26	29	36	41
Rated current max. A		59.2	64.2	69.2	84.1	89.1
Refrigerant		R410a	R410a	R410a	R410a	R410a
Permissible operating pressure (p. max.) bar		45	45	45	45	45
Operating temperature range		-20°C...+43°C	-20°C...+43°C	-20°C...+43°C	-20°C...+43°C	-20°C...+43°C
Temperature of liquid		+5°C...+15°C	+5°C...+15°C	+5°C...+15°C	+5°C...+15°C	+5°C...+15°C
Pump capacity l/min		240	240	240	470	470
Pump pressure bar		2.5	2.5	2.5	2.5	2.5
Number of cooling circuits		2	2	2	2	2
Steel tank, with 10 mm condensate insulation		■	■	■	■	■
Tank capacity l		200	200	200	300	300
Water connection		G 2½" internal thread	G 2½" internal thread	G 2½" internal thread	G 2½" internal thread	G 2½" internal thread
Weight as delivered kg		896.0	906.0	912.0	1000.0	1000.0
Operating weight kg		1096.0	1106.0	1112.0	1300.0	1300.0
Colour		RAL 9002	RAL 9002	RAL 9002	RAL 9005	RAL 9005

Total cooling output 155 – 261 kW

Model No.	Packs of	3232.801	3232.811	3232.821	3232.891	3232.831
Total cooling output kW		155	172	196	235	261
Width mm		1100	1100	1100	1500	2200
Height mm		1875	1875	1875	1975	2450
Depth mm		3240	3240	4240	4350	3400
Rated operating voltage V, ~, Hz		400, 3~, 50	400, 3~, 50	400, 3~, 50	400, 3~, 50	400, 3~, 50
Air throughput at max. cooling output m³/h		32600	32600	50000	49000	72800
Power consumption kW		47	52	60	70	80
Rated current max. A		108	120	127	149	181
Refrigerant		R410a	R410a	R410a	R410a	R410a
Permissible operating pressure (p. max.) bar		45	45	45	45	45
Operating temperature range		-20°C...+43°C	-20°C...+43°C	-20°C...+43°C	-20°C...+43°C	-20°C...+43°C
Temperature of liquid		+5°C...+15°C	+5°C...+15°C	+5°C...+15°C	+5°C...+15°C	+5°C...+15°C
Pump capacity l/min		500	500	500	500	810
Pump pressure bar		2.5	2.5	2.5	2.5	2.5
Number of cooling circuits		2	2	2	2	2
Steel tank, with 10 mm condensate insulation		■	■	■	■	■
Tank capacity l		300	300	300	300	700
Water connection		G 2½" internal thread	G 2½" internal thread	G 2½" internal thread	G 2½" internal thread	G 3" internal thread
Weight as delivered kg		1000.0	1000.0	1000.0	1900.0	2500.0
Operating weight kg		1300.0	1300.0	1300.0	2200.0	3200.0
Colour		RAL 9002	RAL 9002	RAL 9002	RAL 9002	RAL 9002

Online presence – Rittal's IT expertise



- Innovative IT solutions
- Consulting, service and operational models
- Specific application examples

www.rittal.com/it-solutions/en



New

Chillers for IT cooling

Total cooling output 291 – 481 kW

Model No.	Packs of	3232.841	3232.851	3232.861	3232.871	3232.881
Total cooling output kW		291	326	387	430	481
Width mm		2200	2200	2200	2200	2200
Height mm		2450	2450	2450	2450	2450
Depth mm		3400	3400	4250	4250	4250
Rated operating voltage V, ~, Hz		400, 3~, 50	400, 3~, 50	400, 3~, 50	400, 3~, 50	400, 3~, 50
Air throughput at max. cooling output m³/h		71500	70200	106200	104100	102000
Power consumption kW		93	106	121	141	159
Rated current max. A		203	225	293	307	336
Refrigerant		R410a	R410a	R410a	R410a	R410a
Permissible operating pressure (p. max.) bar		45	45	45	45	45
Operating temperature range		-20°C...+43°C	-20°C...+43°C	-20°C...+43°C	-20°C...+43°C	-20°C...+43°C
Temperature of liquid		+5°C...+15°C	+5°C...+15°C	+5°C...+15°C	+5°C...+15°C	+5°C...+15°C
Pump capacity l/min		810	810	1200	1200	1200
Pump pressure bar		2.5	2.5	2.5	2.5	2.5
Number of cooling circuits		2	2	2	2	2
Steel tank, with 10 mm condensate insulation		■	■	■	■	■
Tank capacity l		700	700	700	700	700
Water connection		G 3" internal thread	G 3" internal thread	G 4" internal thread	G 4" internal thread	G 4" internal thread
Weight as delivered kg		2700.0	2800.0	3100.0	3000.0	3600.0
Operating weight kg		3400.0	3500.0	3800.0	3700.0	4300.0
Colour		RAL 9002	RAL 9002	RAL 9002	RAL 9002	RAL 9002

Chillers for IT cooling

Rittal IT chillers are available in the cooling output range from 15 to 481 kW. The chillers supply rack, suite and room climate control solutions with cooling medium at a predefined temperature via the integral pump and cooling circuit.



- Speed-controlled or constant pumps
- Redundant pumps
- Hydraulic modules
- Free cooling
- SNMP/Modbus monitoring
- Winter kit
- Efficiency kit

Rittal – The System.

Faster – better – everywhere.

Rittal Edge Data Center

Quickly and easily build IT environments to meet the challenges of Industry 4.0 and the Internet of Things (IoT) – with standardised, preconfigured infrastructure modules from Rittal.

A Rittal Edge Data Center is comprised of two, four, six or eight Rittal TS IT racks, plus components for climate control, power distribution, UPS, fire protection, monitoring and access protection, tailored to the specific application.



ENCLOSURES

POWER DISTRIBUTION

CLIMATE CONTROL

IT INFRASTRUCTURE

SOFTWARE & SERVICES



FRIEDHELM LOH GROUP

Rittal – The System.

Faster – better – everywhere.

- Enclosures
- Power Distribution
- Climate Control
- IT Infrastructure
- Software & Services

You can find the contact details of all Rittal companies throughout the world here.



www.rittal.com/contact

ENCLOSURES

POWER DISTRIBUTION

CLIMATE CONTROL

IT INFRASTRUCTURE

SOFTWARE & SERVICES



FRIEDHELM LOH GROUP