

Remote I/O system CPX-AP-A

FESTO

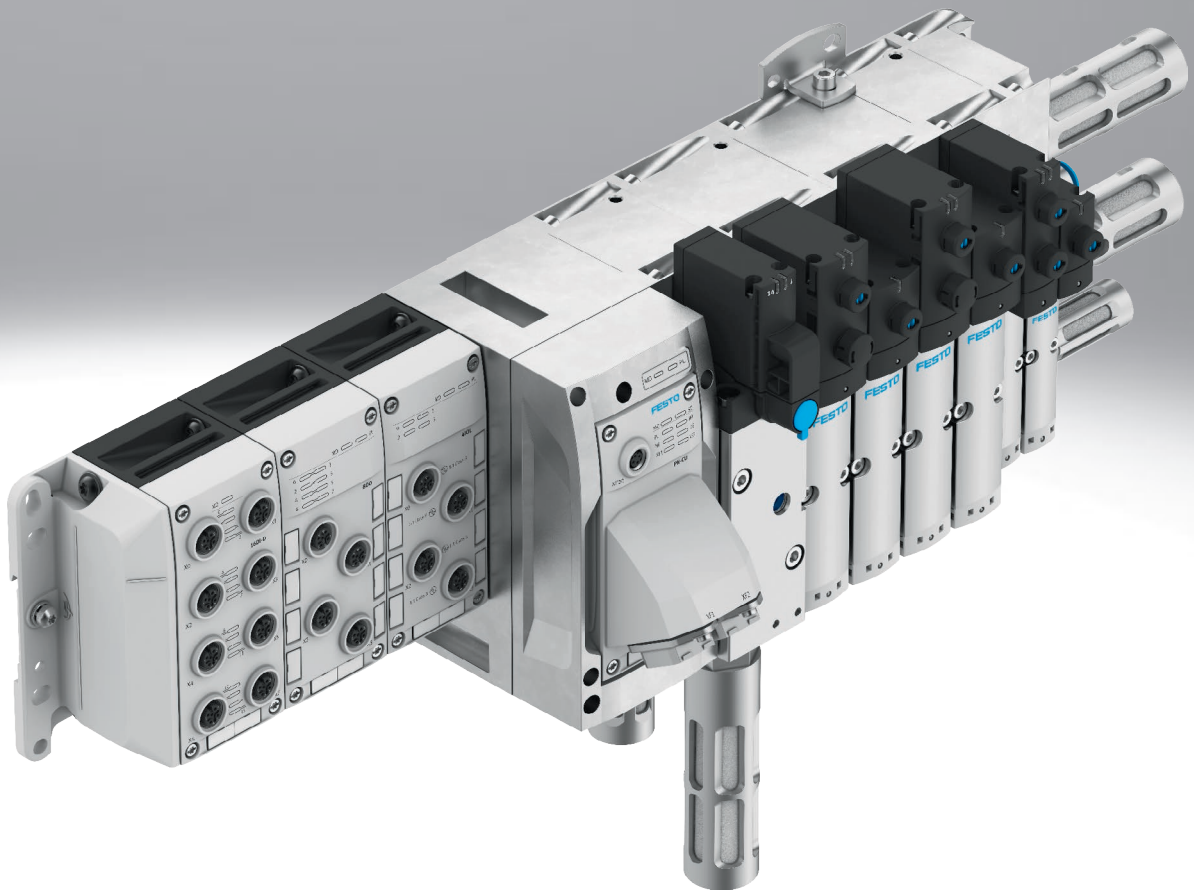

Key features

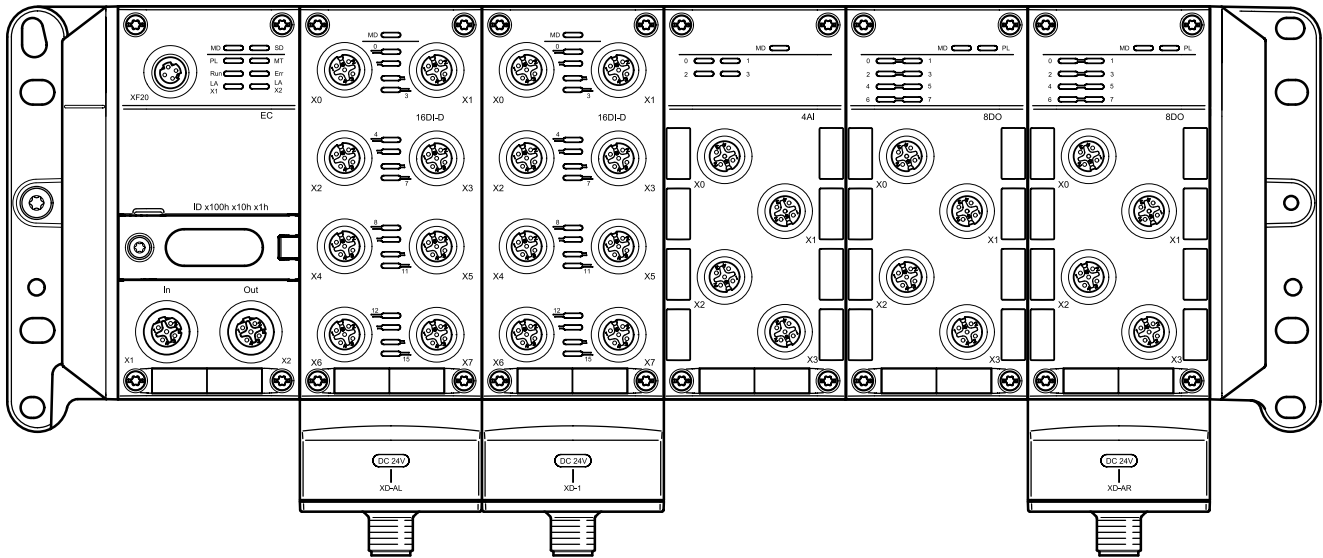

Key features

- Modular and lightweight IO system with IP65/IP67 protection
- Can be adapted to Festo valve terminals
- Highly flexible remote IO system with maximum performance
- Real-time capability, transmission rate of 200 Mbps full duplex
- Parameterisable and scalable
- Up to 15 modules in one remote I/O system CPX-AP-A
- Interlinking blocks are connected using angled fitting
- Complete IO-Link master V1.1 with data storage mechanism including device parameterisation tool
- Dedicated data channel for acyclic data (events, diagnostics, parameters) which will be used for big data (status data for connected peripherals) without influencing the deterministic behaviour of the system.
- Transmission of the cyclic process data independently of the non-time-critical data.
- Easy to integrate into standard host systems
- Extended diagnostics and predictive maintenance information is available, such as valve switching cycle counter and cable quality monitoring
- Presentation of I4.0 features
- Integrated web server
- Festo Automation Suite plug-in for extended engineering and diagnostics
- Easy to mount in any position on any mounting wall using end plates or ITEM profiles and DIN rail. Suitable for motion applications with high G-forces (up to 5 G)
- Suitable for robot applications
- Separate power supply and communications cable for establishing voltage zones (additional supply possible for every module)
- Stable data transfer and sturdy thank to use of standard cables
- 16 A acceptable current load/logic at 24 V DC
- Galvanically isolated output channels
- Digital electronic rating plate available
- Commissioning using normal tools from the PLC manufacturer or with the Festo Automation Suite
- High level of EMC
- Flame-retardant, halogen-free material (ideal for welding applications)

Ordering data – Product options

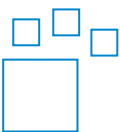



Configurable product
This product and all its product options can be ordered using the configurator.

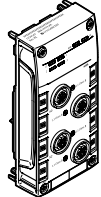

The configurator can be found at
→ www.festo.com/catalogue/...
Enter the part number or the type.

Part no.	Type
8079933	CPX-AP-A
8000810	VTUX-A-P-APA
8000815	VTUX-A-S-APA
8130719	VTSA-F-FB-AP
8130722	VTSA-F-CB-AP
8130716	VTSA-FB-AP
550808	MPA-FB-AP-VI

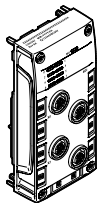

Product range overview

Function	Version	Type	→ Page		
Bus interface		PROFINET CPX-AP-A-PN-M12 CPX-AP-A-PN-CU CPX-AP-A-PN-FO	<ul style="list-style-type: none"> • Actuation via PROFINET • Two PROFINET connections • One connection for system communication • Connection technology RJ45, M12x1 D-coded or SCRJ 	18	
		EtherCAT®	CPX-AP-A-EC-M12	<ul style="list-style-type: none"> • Actuation via EtherCAT® • Two EtherCAT® connections • One connection for system communication • Connection technology M12x1 D-coded 	23
		EtherNet/IP	CPX-AP-A-EP-M12	<ul style="list-style-type: none"> • Actuation via EtherNet/IP • Two Ethernet connections • One connection for system communication • Connection technology M12x1 D-coded 	27
IO-Link master		4 IO-Link® connections	CPX-AP-A-4IOL-M12	<ul style="list-style-type: none"> • LED indicator • Master V 1.1 	31
AP interface		2 AP connections	CPX-AP-A-EPLI CPX-AP-A-EPLI-S	<ul style="list-style-type: none"> • LED indicator • Two AP interfaces • Power transmission • Power supply 	35

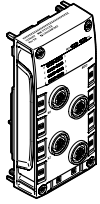
Product range overview

Function	Version	Type		→ Page	
Input module	Digital 	8 inputs	CPX-AP-A-8DI-M8-3P	<ul style="list-style-type: none"> Electrical connection M8x1, 3-pin LED indicator Diagnostics per module PNP (positive switching) Characteristic curve of inputs to IEC 61131-2, type 3 	41
			CPX-AP-A-8DI-M12-5P	<ul style="list-style-type: none"> Electrical connection M12x1, 5-pin LED indicator Diagnostics per module PNP (positive switching) Characteristic curve of inputs to IEC 61131-2, type 3 	41
			CPX-AP-A-8DI-PI	<ul style="list-style-type: none"> Electrical connection, spring-loaded terminal LED indicator Diagnostics per module PNP (positive switching) Characteristic curve of inputs to IEC 61131-2, type 3 	41
		16 inputs	CPX-AP-A-16DI-D-M12-5P	<ul style="list-style-type: none"> Electrical connection M12x1, 5-pin LED indicator Diagnostics per channel PNP (positive switching) Characteristic curve of inputs to IEC 61131-2, type 3 	41
		Analogue 	4 inputs	CPX-AP-A-4AI-U-I-RTD-M12	<ul style="list-style-type: none"> Electrical connection M12x1, 5-pin LED indicator Diagnostics per module Measured variable: voltage, current, temperature and resistance
Output module	Digital 	8 outputs	CPX-AP-A-8DO-M8-3P	<ul style="list-style-type: none"> Electrical connection M8x1, 3-pin LED indicator Diagnostics per channel Diagnostics per module PNP (positive switching) Characteristic curve of outputs to IEC 61131-2, type 0.5 	52
			CPX-AP-A-8DO-M12-5P	<ul style="list-style-type: none"> Electrical connection M12x1, 5-pin LED indicator Diagnostics per channel Diagnostics per module PNP (positive switching) Characteristic curve of outputs to IEC 61131-2, type 0.5 	52
			CPX-AP-A-8HDO-M12-5P	<ul style="list-style-type: none"> Electrical connection M12x1, 5-pin LED indicator Diagnostics per channel Diagnostics per module PNP (positive switching) Characteristic curve of outputs to IEC 61131-2, type 2 	52
			CPX-AP-A-8DO-PI	<ul style="list-style-type: none"> Electrical connection, spring-loaded terminal LED indicator Diagnostics per channel Diagnostics per module PNP (positive switching) Characteristic curve of outputs to IEC 61131-2, type 0.5 	52

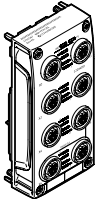
Product range overview

Function	Version	Type	→ Page	
Input/output module	Digital  <ul style="list-style-type: none"> • 12 inputs • 4 outputs 	CPX-AP-A-12DI4DO-M8-4P	<ul style="list-style-type: none"> • Electrical connection M8x1, 4-pin • LED indicator • Diagnostics per channel (outputs only) • Diagnostics per module (outputs and inputs) • PNP (positive switching) • Characteristic curve of inputs to IEC 61131-2, type 3 • Characteristic curve of outputs to IEC 61131-2, type 0.5 	58
		CPX-AP-A-12DI4DO-M12-5P	<ul style="list-style-type: none"> • Electrical connection M12x1, 5-pin • LED indicator • Diagnostics per channel (outputs only) • Diagnostics per module (outputs and inputs) • PNP (positive switching) • Characteristic curve of inputs to IEC 61131-2, type 3 • Characteristic curve of outputs to IEC 61131-2, type 0.5 	58
		CPX-AP-A-12DI4DO-PI	<ul style="list-style-type: none"> • Electrical connection, spring-loaded terminal • LED indicator • Diagnostics per channel (outputs only) • Diagnostics per module (outputs and inputs) • PNP (positive switching) • Characteristic curve of inputs to IEC 61131-2, type 3 • Characteristic curve of outputs to IEC 61131-2, type 0.5 	58
Input/output module PROFIsafe	Digital  <ul style="list-style-type: none"> • 6 inputs • 3 outputs 	CPX-AP-A-6FDI3FDO-PS-M12-5P	<ul style="list-style-type: none"> • Electrical connection M12x1, 5-pin • LED indicator • Diagnostics per channel (outputs only) • Diagnostics per module (outputs and inputs) • PNP (positive switching) • Characteristic curve of inputs to IEC 61131-2, 2-wire and 3-wire • Characteristic curve of outputs to IEC 61131-2, type 2 	<?>

Product range overview

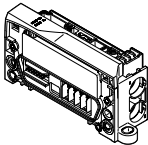
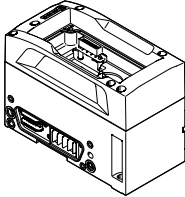
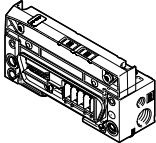
Function	Version	Type	→ Page
Pneumatic interface for valve terminal	Valve terminals VTUX		
		<ul style="list-style-type: none"> Up to 120 solenoid coils 	VABX-A-P-EL-E12-APA-SHUH-XL VABX-A-S-EL-E12-APA-SHUH-XL
			<ul style="list-style-type: none"> LED indicator 1 valve size (10 mm) 2x 3/2-way valves 5/2-way valves 5/3-way valve Flow rates of up to 670 l/min
	Valve terminals VTSA		
		<ul style="list-style-type: none"> 12, 16, 24 or 32 valve positions Up to 32 solenoid coils With 3 safe internal zones (optional) 	VABA-S6-1-X5 VABA-S6-1-X5-CB VABA-S6-1-X5-F5-CB
		<ul style="list-style-type: none"> 12, 16, 24 or 32 valve positions Up to 32 solenoid coils With integrated power supply and power transmission (optional) 	VABA-S6-1-X5-F3-CB VABA-S6-1-X5-F4 VABA-S6-1-X5-F4-CB
			<ul style="list-style-type: none"> LED indicator 4 valve sizes (18 mm, 26 mm, 42 mm and 52 mm) 2x 2/2-way valves 2x 3/2-way valves 5/2-way valves 5/3-way valves Wide range of special functions (switching position sensing, pilot air switching valve, soft-start valve, vacuum applications) 550 ... 2900 l/min flow rate
	Valve terminals MPA-S		
		–	VMPA-AP-EPL-G VMPA-AP-EPL-E
			<ul style="list-style-type: none"> LED indicator 3 valve sizes (10 mm, 14 mm and 20 mm) 5/2-way valves 2x 3/2-way valves 5/3-way valves 2x 2/2-way valves 1x 3/2-way valves with external compressed air supply Manual pressure regulators Pilot air switching valve Proportional pressure regulators Pressure sensor 360 ... 850 l/min flow rate

Key features – Mounting

Assembly

Wall mounting

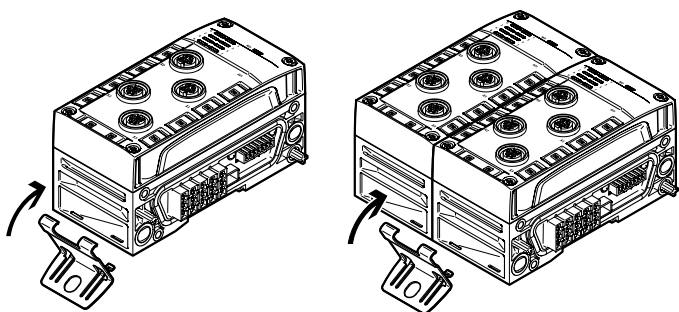

The end plates of the remote I/O system, the valve terminal and the pneumatic interface include mounting holes for wall mounting.

Additional mounting brackets for the interlinking blocks of the remote I/O system are available for longer versions.

With more than 7 interlinking blocks, a mounting bracket is required every 15 cm (corresponds to 3 interlinking blocks).

The mounting brackets can be attached to one interlinking block or between two interlinking blocks.

DIN rail mounting

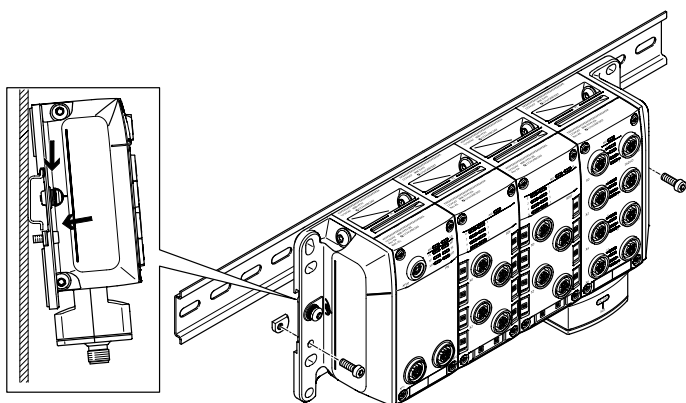

The DIN rail mounting is part of the rear profile of the interlinking blocks, the end plates and the pneumatic interface. The remote I/O system can be attached to the DIN rail using the DIN rail mounting kit.

The remote I/O system is first hooked onto the DIN rail,

then swivelled onto the DIN rail and secured in place with the clamping piece.

Mounting on support system with valve terminal VTSA/VTSA-F/VTSA-F-CB

When mounting on a support system, only the mounting holes in the end plates of the remote I/O system, the valve terminal and in the pneumatic interface are available.

There is no option to use mounting brackets here, and the maximum number of interlinking blocks is limited to 6 (30 cm).

The corresponding mounting kit is required for the left end plate.

Mounting on a support system without valve terminal is not envisaged.

Key features – Mounting

Assembly

Assembly

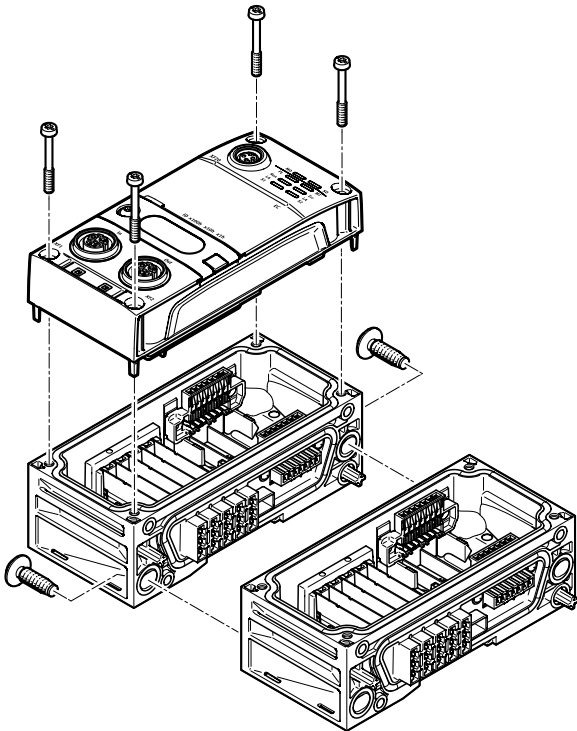

The interlinking blocks are mechanically connected using an angled fitting. The CPX terminal can thus be expanded at any time.

The advantages of polymer (low weight) and metal (sturdy, high EMC compatibility) are perfectly combined by using high-quality polymer materials.

Labelling

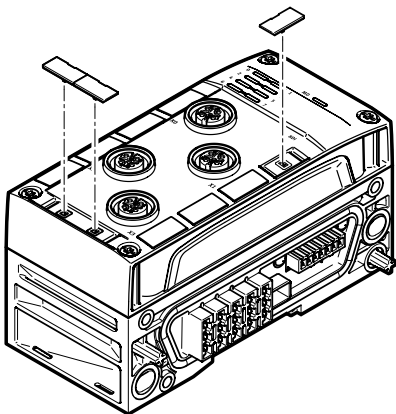

All modules are supplied with the same, clip-on inscription labels. The inscription label is made up of two parts and can be divided into two smaller sections if required.

Labelling templates can be downloaded from the Support Portal:
 → Internet: CPX-AP-A
 In the “Software” area.

Key features – Power supply

Power supply concept

In principle, the remote I/O system CPX-AP-A has two separate electrical circuits:

- For the module electronics and the power supply for connected sensors
- For connected outputs and valves

Interlinking blocks represent the backbone of the remote I/O system with all supply cables.

They provide the power supply for the modules used on them as well as their bus connections. Additionally, the end plate with AP interface offers a power supply option.

The interlinking blocks provide either an easy-to-install central power supply for the entire remote I/O system or galvanically isolated, all-pin disconnectable potential groups/voltage segments or power transmission.

Choice of connection technology:

- M18
- 7/8"
- M12x1, L-coded
- M8x1, A-coded
- Push-pull to IEC 61076-3-126

System performance

Diagnostics

Detailed diagnostic functions are needed in order to quickly locate the causes of errors in the electrical installation and therefore reduce downtimes in the production plant.

A basic distinction is made between on-the-spot diagnostics using LEDs and diagnostics using a bus interface.

The remote I/O system CPX-AP-A supports on-the-spot diagnostics using LED indicators on each module. This is separate from the connection area and therefore provides an easy and good visual view of status and diagnostic information.

Module and channel-specific diagnostics are supported, for example:

- Undervoltage detection
- Short circuit detection

The diagnostic messages can be read out via the bus interface in the higher-order controller and visualised for the central recording and evaluation of error causes. This is done using the individual bus-specific channels.

Indicator lights

Each module has a row of module-specific LEDs for indicating the operating status of the module and of the connected sensors or actuators.

Parameterisation

Various parameters are available for reading out information about the modules in the remote I/O system CPX-AP-A and for configuring the modules to the application.

The parameters are typically accessed via the higher-order controller.

Key features – Addressing

Addressing

The various modules of the CPX-AP-A occupy a different number of addresses within the CPX-AP-A system. The maximum address space for the bus interface depends on the performance of the fieldbus systems.

Maximum system configuration:

- 80 modules per AP string
- 1 bus interface
- 14 input and/or input/output modules and/or pneumatic interface per CPX-AP-A terminal

Addresses are allocated automatically. The bus interface is assigned the address "1", all other modules are assigned an address in increasing value from left to right, viewed from the bus interface.



Note

Please refer to the detailed description of the configuration/addressing rules in the technical data for the CPX-AP-A bus interface.

The maximum system configuration can be limited in individual cases by exceeding the address space or limitations of the higher-order controller.

Overview – Address space for CPX-AP-A bus interface

	Protocol	Max. total Inputs	Outputs
CPX-AP-A-PN-M12	PROFINET	1024 bytes	1024 bytes
CPX-AP-A-PN-CU	PROFINET	1024 bytes	1024 bytes
CPX-AP-A-PN-FO	PROFINET	1024 bytes	1024 bytes
CPX-AP-A-EC-M12	EtherCAT®	1024 bytes	1024 bytes
CPX-AP-A-EP-M12	EtherNet/IP	4096 bytes	4096 bytes



Note

The bandwidth of the bus interface can be restricted by the choice of module and the maximum number of modules.

Key features – Addressing

Overview – Allocated addresses for CPX-AP-A modules		Inputs [bytes]	Outputs [bytes]
CPX-AP-A-4IOL-M12	IO-Link master	12 ... 132	8 ... 128
CPX-AP-A-EPLI	AP connection, address consumption depends on the additional connected components.	–	–
CPX-AP-A-8DI-M8-3P	Digital input module, 8 inputs	1	–
CPX-AP-A-8DI-M12-5P			
CPX-AP-A-8DI-PI			
CPX-AP-A-16DI-D-M12-5P	Digital input module, 16 inputs	2	–
CPX-AP-A-4AI-U-I-RTD-M12	Analogue input module, 4 inputs	8	–
CPX-AP-A-8DO-M8-3P	Digital output module, 8 outputs	–	1
CPX-AP-A-8DO-M12-5P			
CPX-AP-A-8HDO-M12-5P			
CPX-AP-A-8DO-PI			
CPX-AP-A-12DI4DO-M8-4P	Digital input/output module, 12 inputs/4 outputs	2	1
CPX-AP-A-12DI4DO-M12-5P			
CPX-AP-A-12DI4DO-PI			
CPX-AP-A-6FDI3FDO-PS-M12-5P	Digital input/output module PROFIsafe, 6 inputs/3 outputs	5	6
VABX-A-S-EL-E12-APA-SHUH-XL	Pneumatic interface to valve terminal VTUX, maximum 120 valve coils, address consumption depends on the connected additional components (valves, etc.)	–	–
VABX-A-P-EL-E12-APA-SHUH-XL	Pneumatic interface to valve terminal VTUX, maximum 32 solenoid coils	–	4
VABA-S6-1-X5	Pneumatic interface to valve terminal VTSA, VTSA-F, maximum 32 solenoid coils	–	3
VABA-S6-1-X5-F4			
VABA-S6-1-X5-CB	Pneumatic interface to valve terminal VTSA-F-CB, maximum 24 solenoid coils	–	4
VABA-S6-1-X5-F3-CB			
VABA-S6-1-X5-F4-CB			
VABA-S6-1-X5-F5-CB			

Example of CPX-AP-A-PN-M12 (PROFINET)			
	Inputs [bytes]	Outputs [bytes]	Remarks
8x CPX-AP-A-16DI-D-M12-5P	16	–	<ul style="list-style-type: none"> The maximum number of modules is 15 CPX-AP-A modules The available address space (1024 bytes) is not fully used up Further modules can be configured via AP interface
2x CPX-AP-A-8DO-M12-5P	–	2	
3x CPX-AP-A-4IOL-M12	396	384	
1x VABA-S6-1-X5-F4	–	4	
Assigned address space	412	390	

Datasheet – Remote I/O system



EtherCAT

Central remote I/O system for connecting sensors and controlling actuators and valves in an industrial environment.

EtherNet/IP

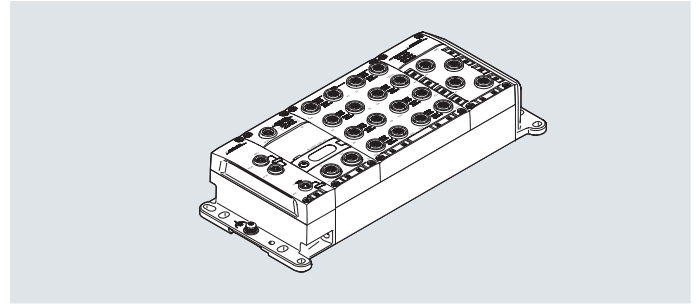
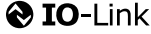

General technical data – Remote I/O system

Protocol	AP
Electrical control	AP interface, Ethernet
Max. number of modules	15
Max. address volume for inputs	1024 bytes 4096 bytes
Note on inputs	EP: 488 bytes Modbus: 4096 bytes
Max. address volume for outputs	1024 bytes 4096 bytes
Note on outputs	EP: 496 bytes Modbus: 4096 bytes
Configuration support	EDS file ESI file GSDML file IODD file
Module parameters	FDevice destination address FDevice source address Configuration of voltage monitoring load supply PL Behaviour after short circuit/overload at the output
Channel parameter	Diagnostics activated for IO-Link® device lost Input debounce time Measured value smoothing Port mode Signal range Target deviceID Target vendorID Target cycle time Lower/upper limits Linear scaling activation Unit for temperature measurement Hysteresis for measured value monitoring
Internal cycle time	< 1 ms
Reverse polarity protection	Yes
Mounting position	Any, on DIN rail: horizontal

Datasheet – Remote I/O system

Diagnostic information – Remote I/O system	
Diagnosics via LED	(Outputs) Diagnostics per channel (Outputs) Power supply load (Inputs-outputs) Diagnostics per module (Inputs-outputs) Status per channel Diagnostics per channel Diagnostics per module EtherCAT RUN Ethernet/IP communication PROFINET communication Power supply, electronics/sensors Power supply load Status per channel Status per module System diagnostics Maintenance required
Diagnosics via bus	APDD invalid Load switch-off Communication error Overvoltage electronics/sensors Overvoltage load Undervoltage electronics/sensors Undervoltage load
Diagnosics via internal communication	Load switch-off Wire break IO-Link® event Communication error Short circuit/overload output signal Short circuit/overload in sensor supply Short circuit/overload Parameter error Parameterisation error Overload at analogue inputs Upper limit value not observed Overvoltage electronics/sensors Overvoltage load Underflow/overflow Lower limit value not observed Undervoltage electronics/sensors Undervoltage load

Datasheet – Remote I/O system

Technical data – Remote I/O system interfaces	
Note on fieldbus interface	All information relevant for CPX-AP can be read out via the Ethernet/fieldbus interfaces and changed depending on the function; Auto MDI, the bus module does a crossover check; firmware update via Ethernet/fieldbus interface; I&M functionality according to PNO is supported.
Fieldbus interface, protocol	ACD (Address Conflict Detection) DLR (Device Level Ring) EtherCAT® EtherCAT CoE EtherCAT Distributed Clocks (DC) EtherCAT EoE EtherCAT FoE EtherCAT Modular Device Profile (MDP) EtherNet/IP EtherNet/IP QoS EtherNet/IP Quickconnect LLDP MRP, MRPD (ring redundancy) Modbus/TCP (Modbus/UDP) PROFINET FSU PROFINET I&MO .. 3 PROFINET IRT PROFINET RT PROFINET shared device S2 system redundancy SNMP
Fieldbus interface, function	Incoming/outgoing bus connection
Fieldbus interface, transmission rate	100 Mbps
Fieldbus interface, type	Ethernet
Fieldbus interface, type of connection	2 x socket
Fieldbus interface, connection technology	M12x1, D-coded to EN 61076-2-101 RJ45 to IEC 61076-3-117 (V14)
Fieldbus interface, number of pins/cores	4; 8
Fieldbus interface, galvanic isolation	Yes
Power supply, function	Incoming electronics/sensors and load and functional earth
Power supply, connection type	Plug
Power supply, connection technology	7/8" to NFPA/T3.5.29 M12x1, L-coded to EN 61076-2-111 M18x1 Push-pull to IEC 61076-3-126
Power supply, number of pins/cores	4; 5

Datasheet – Remote I/O system

Technical data – Electrical – Remote I/O system

Nominal operating voltage DC for electronics/sensors	24 V
Nominal operating voltage DC load	24 V
Permissible voltage fluctuations, electronics/sensors	± 25%
Permissible voltage fluctuations, load	± 25%
Note on the operating voltage	SELV/PELV power supply units required; note voltage drop
Note on nominal operating voltage DC	Protected extra-low voltage to IEC 60204-1
Power failure buffering	10 ms
Max. power supply	8 ... 16 A
Typ. intrinsic current consumption at nominal operating voltage for electronic system/sensors	0.040 ... 10.000 A
Typ. intrinsic current consumption at nominal operating voltage, load	0.003 ... 10.000 A
Electrical isolation between the supply voltages for electronics/sensors and load/valves	Yes
Protection class	III
Overvoltage category	II
Protection against direct and indirect contact	SELV/PELV power supply units required
Pollution degree	2

Technical data – Mechanical – Remote I/O system

Type of mounting	Direct mounting via through-hole On DIN rail with accessories On mounting frame Screw-clamped With through-hole for M5 screw with accessories With through-hole for M6 screw with accessories With through-hole for M5 screw With through-hole for M6 screw
Product weight	450 ... 5200 g
Dimensions W x L x H	Depending on the configuration
Grid dimension	50.1 mm

Materials – Remote I/O system

Note on materials	RoHS-compliant; free of halogen; free of phosphoric acid ester
LABS (PWIS) conformity	VDMA24364-B2-L

Datasheet – Remote I/O system

Operating and environmental conditions – Remote I/O system	
Ambient temperature	-20 ... 50 °C
Note on ambient temperature	Note ambient temperature derating to IEC 61131-2:2017 Note derating according to user documentation
Storage temperature	-20 ... 70 °C
Corrosion resistance class CRC ¹⁾	1 - low corrosion stress
Relative humidity	5 - 95%, non-condensing
Nominal operating altitude	<= 2000 m ASL (> 79.5 kPa)
Max. setup altitude	3500 m
Note on max. setup altitude	> 2000 m ASL (< 79.5 kPa) Note ambient temperature derating to IEC 61131-2:2017 Note derating according to user documentation
Vibration resistant	Transport application test with severity level 2 to FN 942017-4 and EN 60068-2-6
Note on vibration resistance	SG1 on DIN rail SG2 on direct mounting Transport application test with severity level 1 to FN 942017-4 and EN 60068-2-6
Shock resistance	Shock test with severity level 2 to FN 942017-5 and EN 60068-2-27
Note on shock resistance	30 g/11 ms to EN 60068-2-27 SG1 on DIN rail SG2 on direct mounting Shock test with severity level 1 to FN 942017-5 and EN 60068-2-27
CE marking (see declaration of conformity) ²⁾	To EU EMC Directive, to EU-RoHS Directive
UKCA marking (see declaration of conformity) ³⁾	To UK EMC regulations; to UK RoHS regulations
KC marking	KC EMC
Certification	RCM; c UL us - Listed (OL)
Certificate-issuing authority	UL E239998
Degree of protection	IP65; IP67
Note on degree of protection	Unused connections sealed

1) More information www.festo.com/x/topic/crc

2) More information www.festo.com/catalogue/... Support/Downloads.

3) More information www.festo.com/catalogue/... Support/Downloads.

Ordering data		Part no.	Type
	Remote I/O system	8079933	CPX-AP-A
		Configurable product This product and all its product options can be ordered using the configurator.	

Datasheet – PROFINET interface



Interface for operating the remote I/O system CPX-AP-A on PROFINET. Data is transferred on the basis of the Ethernet standard and TCP/IP technology for communication in an industrial environment.

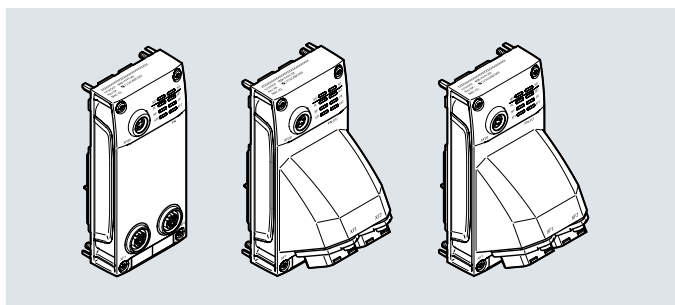

Bus connection

Communication with a higher-order controller takes place via PROFINET with real-time protocol (real time RT or isochronous real time IRT).

The bus connection is provided via two equivalent interfaces which meet Ethernet requirements.

The integrated switch supports star and line topology and enables the network to be divided into segments.

PROFINET implementation

The interface supports the PROFINET protocol on the basis of the Ethernet standard and TCP/IP technology to IEEE802.3.

This guarantees a data exchange with a high data transmission rate, for example I/O data from sensors, actuators or robot controllers, PLCs or process equipment.

In addition, non-real-time critical information such as diagnostic information, configuration information, etc. can be transmitted.

The Ethernet bandwidth is sufficient to transfer both data types (real-time and non-real-time) in parallel.

The interfaces support the PROFenergy profile for energy management. This makes it possible to switch off specific consumers that are not required in order to reduce energy demand.

The crossover detection function (Auto-MDI/MDI-X) is also supported. This means either patch cables or crossover cables can be used.

General technical data – PROFINET interface

Fieldbus interface, connection technology	M12x1, D-coded to EN 61076-2-101	RJ45 to IEC 61076-3-117 (V14)	SCRJ to IEC 61754-24-21
Max. number of modules	80		
Max. address volume for inputs	1,024 bytes		
Max. address volume for outputs	1,024 bytes		
Configuration support	GSDML file		
Module parameters	Configuration of voltage monitoring load supply PL		
Diagnostics via LED	Diagnostics per module; PROFINET communication; power supply for electronics/sensors; power supply for load; system diagnostics; maintenance required		
Diagnostics via bus	APDD invalid; switch-off load supply; communication error; overvoltage electronics/sensors; overvoltage load; undervoltage electronics/sensors; undervoltage load		
Internal cycle time	< 1 ms		
Reverse polarity protection	Yes		
Max. cable length	100 m PROFINET		50 m PROFINET
Mounting position	Any		

Datasheet – PROFINET interface

Technical data – Electrical – PROFINET interface

Fieldbus interface, connection technology	M12x1, D-coded to EN 61076-2-101	RJ45 to IEC 61076-3-117 (V14)	SCRJ to IEC 61754-24-21
Nominal operating voltage DC for electronics/sensors	24 V		
Nominal operating voltage DC load	24 V		
Permissible voltage fluctuations, electronics/sensors	± 25%		
Permissible voltage fluctuations, load	± 25%		
Note on the operating voltage	SELV/PELV power supply units required; note voltage drop		
Note on nominal operating voltage DC	Protected extra-low voltage to IEC 60204-1		
Power failure buffering	10 ms		
Intrinsic current consumption at nominal operating voltage, electronics/sensors	Typical 80 mA	Typical 115 mA	
Intrinsic current consumption at nominal operating voltage, load	Typical 4 mA		
Electrical isolation between the supply voltages for electronics/sensors and load/valves	Yes		
Protection class	III		
Overvoltage category	II		
Pollution degree	2		

Technical data – Fieldbus interface – PROFINET interface

Fieldbus interface, connection technology	M12x1, D-coded to EN 61076-2-101	RJ45 to IEC 61076-3-117 (V14)	SCRJ to IEC 61754-24-21
Fieldbus interface, protocol	LLDP; MRP, MRPD (ring redundancy); PROFINET FSU; PROFINET I&MO .. 3; PROFINET IRT; PROFINET RT; PROFINET shared device; S2 system redundancy; SNMP		
Fieldbus interface, function	Incoming/outgoing bus connection		
Fieldbus interface, transmission rate	100 Mbps		
Fieldbus interface, note on transmission rate	100 Mb, switched Fast Ethernet		
Fieldbus interface, type	Ethernet		
Fieldbus interface, type of connection	2 x socket		
Fieldbus interface, number of pins/cores	4	8	2
Fieldbus interface, galvanic isolation	Yes		

Technical data – Communication interface – PROFINET interface

Communication interface, protocol	AP		
Communication interface, function	System communication XF20 OUT		
Communication interface, connection type	Socket		
Communication interface, connection technology	M8x1, D-coded to EN 61076-2-114		
Communication interface, number of pins/cores	4		
Communication interface, shielding	Yes		

Technical data – Mechanical – PROFINET interface

Fieldbus interface, connection technology	M12x1, D-coded to EN 61076-2-101	RJ45 to IEC 61076-3-117 (V14)	SCRJ to IEC 61754-24-21
Type of mounting	Screw-clamped		
Product weight	108 g	167 g	182 g
Dimensions W x L x H	(incl. interlinking block); 50.1 mm x 107.3 mm x 57.5 mm	(incl. interlinking block); 50.1 mm x 107.3 mm x 94.2 mm	
Grid dimension	50.1 mm		

Datasheet – PROFINET interface

Materials – PROFINET interface

Fieldbus interface, connection technology	M12x1, D-coded to EN 61076-2-101	RJ45 to IEC 61076-3-117 (V14)	SCRJ to IEC 61754-24-21
Cover material	Reinforced PBT		
O-ring material	FPM		
Sealing material	–	NBR	
Flange material	–	Nickel-plated die-cast zinc	
Threaded sleeve material	High-alloy stainless steel		
Screw material	Nickel-plated steel		
Note on materials	RoHS-compliant; free of halogen; free of phosphoric acid ester		
LABS (PWS) conformity	VDMA24364-B2-L		

Operating and environmental conditions – PROFINET interface

Ambient temperature	-20 ... 50 °C
Storage temperature	-20 ... 70 °C
Corrosion resistance class CRC ¹⁾	1 - low corrosion stress
Relative humidity	5 - 95%, non-condensing
Nominal operating altitude	<= 2000 m ASL (> 79.5 kPa)
Note on ambient temperature	Note ambient temperature derating to IEC 61131-2:2017
Max. setup altitude	3,500 m
Note on max. setup altitude	> 2000 m ASL (< 79.5 kPa) Note ambient temperature derating to IEC 61131-2:2017
Vibration resistant	Transport application test with severity level 2 to FN 942017-4 and EN 60068-2-6
Note on vibration resistance	SG1 on DIN rail SG2 on direct mounting Transport application test with severity level 1 to FN 942017-4 and EN 60068-2-6
Shock resistance	Shock test with severity level 2 to FN 942017-5 and EN 60068-2-27
Note on shock resistance	30 g/11 ms to EN 60068-2-27 SG1 on DIN rail SG2 on direct mounting Shock test with severity level 1 to FN 942017-5 and EN 60068-2-27
Material fire test	UL94 V-0 (housing)

1) More information www.festo.com/x/topic/crc

Connection and indicator components – M12 fieldbus interface

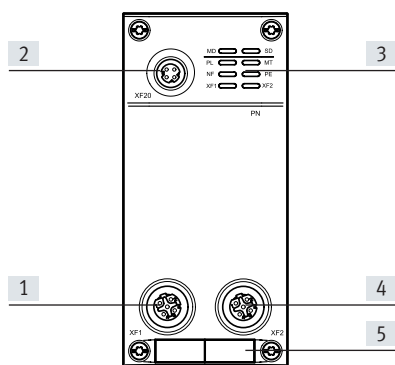

- [1] Network connection 1, PROFINET
- [2] Communication interface
- [3] LED indicators
- [4] Network connection 2, PROFINET
- [5] Space for inscription label

Pin assignment – Fieldbus interface M12

Terminal assignment	Pin	Assignment
	1	TD+
	2	RD+
	3	TD-
	4	RD-

Datasheet – PROFINET interface

Connection and indicator components – Fieldbus interface RJ45

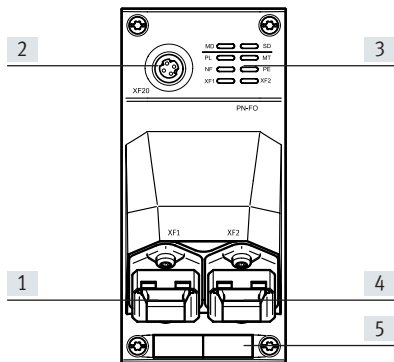

- [1] Network connection 1, PROFINET
- [2] Communication interface
- [3] LED indicators
- [4] Network connection 2, PROFINET
- [5] Space for inscription label

Pin assignment – Fieldbus interface RJ45

Terminal assignment	Pin	Assignment
	1	TD+
	2	TD-
	3	RD+
	6	RD-

Connection and indicator components – Fieldbus interface SCRJ

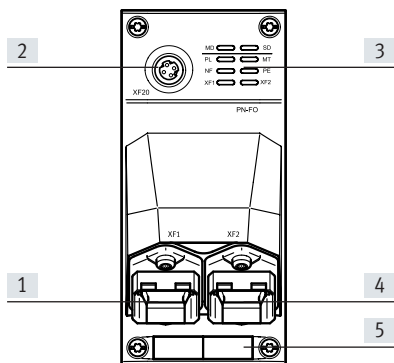









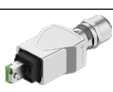

- [1] Network connection 1, PROFINET
- [2] Communication interface
- [3] LED indicators
- [4] Network connection 2, PROFINET
- [5] Space for inscription label

Pin assignment – Fieldbus interface RJ45

Terminal assignment	Pin	Assignment
	1	Output signal
	2	Input signal

Datasheet – PROFINET interface

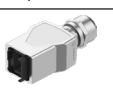
Ordering data		Fieldbus interface, connection technology	Part no.	Type		
	PROFINET interface	M12x1, D-coded to EN 61076-2-101	8129241	CPX-AP-A-PN-M12		
		RJ45 to IEC 61076-3-117 (V14)	8129245	CPX-AP-A-PN-CU		
		SCRJ to IEC 61754-24-21	8129246	CPX-AP-A-PN-FO		
Ordering data – Accessories						
Description		Pack size	Part no.	Type		
Plug connectors for self-assembly						
	For bus connection	Straight plug, M12x1, 4-pin, D-coded	–	543109	NECU-M-S-D12G4-C2-ET	
	–	Plug RJ45, 8-pin	–	5195384	NECC-M-S-R3G8PP-HX-PN	
	–	SC-RJ connector to IEC 61754-24, 2-pin	–	5195381	NOCC-M-S-SCRJG2PP-C5-PN	
Connecting cables						
	Straight plug, M12x1, 4-pin, D-coded	Straight plug, M12x1, 4-pin, D-coded	0.5 m	–	8040446	NEBC-D12G4-ES-0.5-S-D12G4-ET
			1 m	–	8040447	NEBC-D12G4-ES-1-S-D12G4-ET
			3 m	–	8040448	NEBC-D12G4-ES-3-S-D12G4-ET
			5 m	–	8040449	NEBC-D12G4-ES-5-S-D12G4-ET
			10 m	–	8040450	NEBC-D12G4-ES-10-S-D12G4-ET
	Straight plug, M12x1, 4-pin, D-coded	Straight plug, RJ45, 8-pin	1 m	–	8040451	NEBC-D12G4-ES-1-S-R3G4-ET
			3 m	–	8040452	NEBC-D12G4-ES-3-S-R3G4-ET
			5 m	–	8040453	NEBC-D12G4-ES-5-S-R3G4-ET
			10 m	–	8040454	NEBC-D12G4-ES-10-S-R3G4-ET
	Straight plug, M12x1, 4-pin, D-coded	Open end, 4-core	5 m	–	8040456	NEBC-LE4-ES-5-D12G4-ET
Inscription labels						
	For modules CPX-AP-A	Size 6x 12.5 mm, 10 frames with 24 pieces each	240	8087174	ASLR-L-X4-612-P240	
Cover cap						
	For sealing unused connections	For connection M8x1	10	177672	ISK-M8	
		For connection M12x1	10	165592	ISK-M12	
	Cover cap for bus connection	For push-pull connection	–	2873540	CPX-M-AK-D	
	For sealing unused connections	For RJ45 connection	–	8090740	NEAC-M-S-BD-R3SCPP	

Datasheet – EtherCAT® interface



Interface for operating the remote I/O system CPX-AP-A on EtherCAT®. Data is transferred on the basis of the Ethernet standard for communication in an industrial environment.

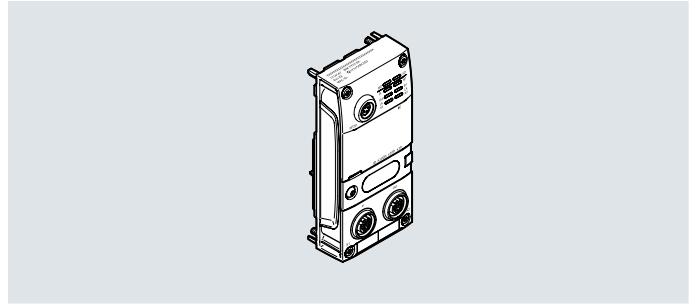

EtherCAT® implementation

The interface supports the EtherCAT® protocol based on the Ethernet standard and TCP/IP technology to IEEE802.3.

This guarantees a data exchange with a high data transmission rate, for example I/O data from sensors or actuators.

The integrated web server provides read and write access to the most important parameters and diagnostics functions of the remote I/O system CPX-AP.

The supported "Distributed Clocks" function, for precise synchronisation of stations in an EtherCAT® network, enables applications that require simultaneously coordinated actions.

The crossover detection function (Auto-MDI/MDI-X) is also supported. This means either patch cables or crossover cables can be used.

General technical data – EtherCAT® interface

Max. number of modules	80
Max. address volume for inputs	1024 bytes
Max. address volume for outputs	1024 bytes
Configuration support	ESI file
Module parameters	Configuration of voltage monitoring load supply PL
Diagnostics via LED	Diagnostics per module; EtherCAT RUN; power supply for electronics/sensors; power supply for load; system diagnostics; maintenance required
Diagnostics via bus	APDD invalid; switch-off load supply; communication error; overvoltage electronics/sensors; overvoltage load; undervoltage electronics/sensors; undervoltage load
Internal cycle time	< 1 ms
Reverse polarity protection	Yes
Max. cable length	100 m EtherCAT®
Mounting position	Any

Technical data – Electrical – EtherCAT® interface

Nominal operating voltage DC for electronics/sensors	24 V
Nominal operating voltage DC load	24 V
Permissible voltage fluctuations, electronics/sensors	± 25%
Permissible voltage fluctuations, load	± 25%
Note on the operating voltage	SELV/PELV power supply units required; note voltage drop
Note on nominal operating voltage DC	Protected extra-low voltage to IEC 60204-1
Power failure buffering	10 ms
Intrinsic current consumption at nominal operating voltage, electronics/sensors	Typical 95 mA
Intrinsic current consumption at nominal operating voltage, load	Typical 3 mA
Electrical isolation between the supply voltages for electronics/sensors and load/valves	Yes
Protection class	III
Overvoltage category	II
Pollution degree	2

Datasheet – EtherCAT® interface

Technical data – Fieldbus interface, EtherCAT® interface

Fieldbus interface, protocol	EtherCAT®; EtherCAT CoE; EtherCAT Distributed Clocks (DC); EtherCAT EoE; EtherCAT FoE; EtherCAT Modular Device Profile (MDP)
Fieldbus interface, function	Incoming/outgoing bus connection
Fieldbus interface, transmission rate	100 Mbps
Fieldbus interface, note on transmission rate	100 Mb, switched Fast Ethernet
Fieldbus interface, type	Ethernet
Fieldbus interface, type of connection	2 x socket
Fieldbus interface, connection technology	M12x1, D-coded to EN 61076-2-101
Fieldbus interface, number of pins/cores	4
Fieldbus interface, galvanic isolation	Yes

Technical data – Communication interface – EtherCAT® interface

Communication interface, protocol	AP
Communication interface, function	System communication XF20 OUT
Communication interface, connection type	Socket
Communication interface, connection technology	M8x1, D-coded to EN 61076-2-114
Communication interface, number of pins/cores	4
Communication interface, shielding	Yes

Technical data – Mechanical – EtherCAT® interface

Type of mounting	Screw-clamped
Product weight	113 g
Dimensions W x L x H	(incl. interlinking block); 50.1 mm × 107.3 mm × 57.5 mm
Grid dimension	50.1 mm

Materials – EtherCAT® interface

Cover material	Reinforced PBT
Inspection window material	PC
O-ring material	FPM
Threaded sleeve material	High-alloy stainless steel
Screw material	Nickel-plated steel
Note on materials	RoHS-compliant; free of halogen; free of phosphoric acid ester
LABS (PWIS) conformity	VDMA24364-B2-L

Datasheet – EtherCAT® interface

Operating and environmental conditions – EtherCAT® interface

Ambient temperature	-20 ... 50 °C
Note on ambient temperature	Note ambient temperature derating to IEC 61131-2:2017
Storage temperature	-20 ... 70 °C
Corrosion resistance class CRC ¹⁾	1 - low corrosion stress
Relative humidity	5 - 95%, non-condensing
Nominal operating altitude	<= 2000 m ASL (> 79.5 kPa)
Max. setup altitude	3500 m
Note on max. setup altitude	> 2000 m ASL (< 79.5 kPa) Note ambient temperature derating to IEC 61131-2:2017
Vibration resistant	Transport application test with severity level 2 to FN 942017-4 and EN 60068-2-6
Note on vibration resistance	SG1 on DIN rail SG2 on direct mounting Transport application test with severity level 1 to FN 942017-4 and EN 60068-2-6
Shock resistance	Shock test with severity level 2 to FN 942017-5 and EN 60068-2-27
Note on shock resistance	30 g/11 ms to EN 60068-2-27 SG1 on DIN rail SG2 on direct mounting Shock test with severity level 1 to FN 942017-5 and EN 60068-2-27
Material fire test	UL94 V-0 (housing)





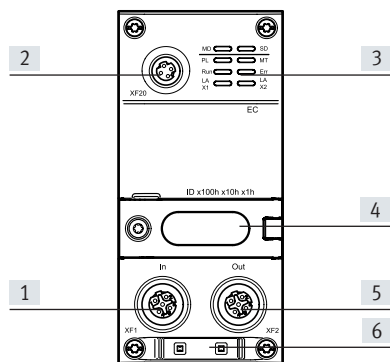

1) More information www.festo.com/x/topic/crc

Connection and indicator components



- [1] Network connection 1, EtherCAT®
- [2] Communication interface
- [3] LED indicators
- [4] Rotary switch cover
- [5] Network connection 2, EtherCAT®
- [6] Space for inscription label

Datasheet – EtherCAT® interface

Ordering data		Part no.	Type			
	EtherCAT® interface	8129243	CPX-AP-A-EC-M12			
Ordering data – Accessories						
Description		Pack size	Part no.	Type		
Plug connectors for self-assembly						
	For bus connection	Straight plug, M12x1, 4-pin, D-coded	–	543109	NECU-M-S-D12G4-C2-ET	
Connecting cables						
	Straight plug, M12x1, 4-pin, D-coded	Straight plug, M12x1, 4-pin, D-coded	0.5 m	–	8040446	NEBC-D12G4-ES-0.5-S-D12G4-ET
			1 m	–	8040447	NEBC-D12G4-ES-1-S-D12G4-ET
			3 m	–	8040448	NEBC-D12G4-ES-3-S-D12G4-ET
			5 m	–	8040449	NEBC-D12G4-ES-5-S-D12G4-ET
			10 m	–	8040450	NEBC-D12G4-ES-10-S-D12G4-ET
	Straight plug, M12x1, 4-pin, D-coded	Straight plug, RJ45, 8-pin	1 m	–	8040451	NEBC-D12G4-ES-1-S-R3G4-ET
			3 m	–	8040452	NEBC-D12G4-ES-3-S-R3G4-ET
			5 m	–	8040453	NEBC-D12G4-ES-5-S-R3G4-ET
			10 m	–	8040454	NEBC-D12G4-ES-10-S-R3G4-ET
	Straight plug, M12x1, 4-pin, D-coded	Open end, 4-core	5 m	–	8040456	NEBC-LE4-ES-5-D12G4-ET
Inscription labels						
	For modules CPX-AP-A	Size 6x 12.5 mm, 10 frames with 24 pieces each	240	8087174	ASLR-L-X4-612-P240	
Cover cap						
	For sealing unused connections	For connection M8x1	10	177672	ISK-M8	
		For connection M12x1	10	165592	ISK-M12	

Datasheet – EtherNet/IP interface

EtherNet/IP™

Interface for operating the remote I/O system CPX-AP-A in an Ethernet network using the protocols EtherNet/IP or Modbus/TCP. Data is transferred on the basis of Industrial Ethernet.

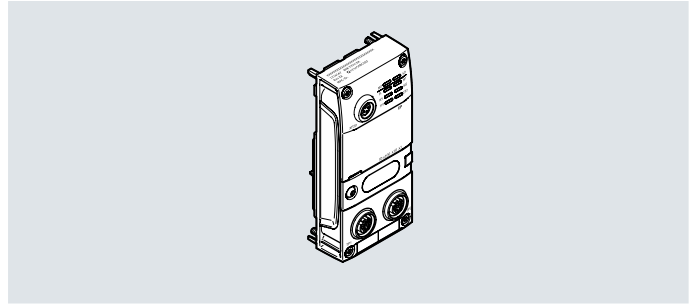

Implementation

EtherNet/IP and Modbus/TCP use the Ethernet standard and TCP/IP technology to IEEE802.3.

This guarantees a data exchange with a high data transmission rate, for example data from sensors, actuators or robot controllers, PLCs or process equipment.

In addition, non-real-time critical information such as diagnostic information, configuration information, etc. can be transmitted.

The Ethernet bandwidth is sufficient to transfer both data types (real-time and non-real-time) in parallel.

General technical data – EtherNet/IP interface

Max. number of modules	80
Max. address volume for inputs	4096 bytes
Note on inputs	EP: 488 bytes; Modbus®: 4096 bytes
Max. address volume for outputs	4096 bytes
Note on outputs	EP: 496 bytes; Modbus®: 4096 bytes
Configuration support	EDS file
Module parameters	Configuration of voltage monitoring load supply PL
Diagnostics via LED	Diagnostics per module; Ethernet/IP communication; power supply for electronics/sensors; power supply for load; system diagnostics; maintenance required
Diagnostics via bus	APDD invalid; switch-off load supply; communication error; overvoltage electronics/sensors; overvoltage load; undervoltage electronics/sensors; undervoltage load
Internal cycle time	< 1 ms
Reverse polarity protection	Yes
Max. cable length	100 m Ethernet/IP
Mounting position	Any

Technical data – Electrical – EtherNet/IP interface

Nominal operating voltage DC for electronics/sensors	24 V
Nominal operating voltage DC load	24 V
Permissible voltage fluctuations, electronics/sensors	± 25%
Permissible voltage fluctuations, load	± 25%
Note on the operating voltage	SELV/PELV power supply units required; note voltage drop
Note on nominal operating voltage DC	Protected extra-low voltage to IEC 60204-1
Power failure buffering	10 ms
Intrinsic current consumption at nominal operating voltage, electronics/sensors	Typical 95 mA
Intrinsic current consumption at nominal operating voltage, load	Typical 3 mA
Electrical isolation between the supply voltages for electronics/sensors and load/valves	Yes
Protection class	III
Overvoltage category	II
Pollution degree	2

Datasheet – EtherNet/IP interface

Technical data – Fieldbus interface, EtherNet/IP interface

Fieldbus interface, protocol	ACD (Address Conflict Detection); DLR (Device Level Ring); EtherNet/IP; EtherNet/IP QoS; EtherNet/IP Quickconnect; Modbus/TCP (Modbus/UDP); SNMP
Fieldbus interface, function	Incoming/outgoing bus connection
Fieldbus interface, transmission rate	100 Mbps
Fieldbus interface, note on transmission rate	100 Mb, switched; Fast Ethernet
Fieldbus interface, type	Ethernet
Fieldbus interface, type of connection	2 x socket
Fieldbus interface, connection technology	M12x1, D-coded to EN 61076-2-101
Fieldbus interface, number of pins/cores	4
Fieldbus interface, galvanic isolation	Yes

Technical data – Communication interface – EtherNet/IP interface

Communication interface, protocol	AP
Communication interface, function	System communication XF20 OUT
Communication interface, connection type	Socket
Communication interface, connection technology	M8x1, D-coded to EN 61076-2-114
Communication interface, number of pins/cores	4
Communication interface, shielding	Yes

Technical data – Mechanical – EtherNet/IP interface

Type of mounting	Screw-clamped
Product weight	113 g
Dimensions W x L x H	(incl. interlinking block); 50.1 mm x 107.3 mm x 57.5 mm
Grid dimension	50.1 mm

Werkstoffe – EtherNet/IP Interface

Cover material	Reinforced PBT
Inspection window material	PC
O-ring material	FPM
Threaded sleeve material	High-alloy stainless steel
Screw material	Nickel-plated steel
Note on materials	RoHS-compliant; free of halogen; free of phosphoric acid ester
LABS (PWIS) conformity	VDMA24364-B2-L

Datasheet – EtherNet/IP interface

Operating and environmental conditions – EtherNet/IP interface

Ambient temperature	-20 ... 50 °C
Note on ambient temperature	Note ambient temperature derating to IEC 61131-2:2017
Storage temperature	-20 ... 70 °C
Corrosion resistance class CRC ¹⁾	1 - low corrosion stress
Relative humidity	5 - 95%, non-condensing
Nominal operating altitude	<= 2000 m ASL (> 79.5 kPa)
Max. setup altitude	3500 m
Note on max. setup altitude	> 2000 m ASL (< 79.5 kPa) Note ambient temperature derating to IEC 61131-2:2017
Vibration resistant	Transport application test with severity level 2 to FN 942017-4 and EN 60068-2-6
Note on vibration resistance	SG1 on DIN rail SG2 on direct mounting Transport application test with severity level 1 to FN 942017-4 and EN 60068-2-6
Shock resistance	Shock test with severity level 2 to FN 942017-5 and EN 60068-2-27
Note on shock resistance	30 g/11 ms to EN 60068-2-27 SG1 on DIN rail SG2 on direct mounting Shock test with severity level 1 to FN 942017-5 and EN 60068-2-27
Material fire test	UL94 V-0 (housing)





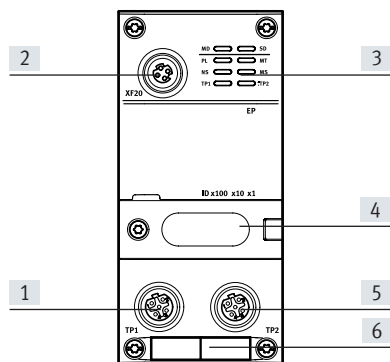

1) More information www.festo.com/x/topic/crc

Connection and indicator components



- [1] Network connection 1, EtherNet/IP
- [2] Communication interface
- [3] LED indicators
- [4] Rotary switch cover
- [5] Network connection 2, EtherNet/IP
- [6] Space for inscription label

Datasheet – EtherNet/IP interface

Ordering data		Part no.	Type			
	EtherNet/IP interface	8129244	CPX-AP-A-EP-M12			
Ordering data – Accessories						
Description	Pack size	Part no.	Type			
Plug connectors for self-assembly						
	For bus connection	Straight plug, M12x1, 4-pin, D-coded	–	543109	NECU-M-S-D12G4-C2-ET	
Connecting cables						
	Straight plug, M12x1, 4-pin, D-coded	Straight plug, M12x1, 4-pin, D-coded	0.5 m	–	8040446	NEBC-D12G4-ES-0.5-S-D12G4-ET
			1 m	–	8040447	NEBC-D12G4-ES-1-S-D12G4-ET
			3 m	–	8040448	NEBC-D12G4-ES-3-S-D12G4-ET
			5 m	–	8040449	NEBC-D12G4-ES-5-S-D12G4-ET
			10 m	–	8040450	NEBC-D12G4-ES-10-S-D12G4-ET
	Straight plug, M12x1, 4-pin, D-coded	Straight plug, RJ45, 8-pin	1 m	–	8040451	NEBC-D12G4-ES-1-S-R3G4-ET
			3 m	–	8040452	NEBC-D12G4-ES-3-S-R3G4-ET
			5 m	–	8040453	NEBC-D12G4-ES-5-S-R3G4-ET
			10 m	–	8040454	NEBC-D12G4-ES-10-S-R3G4-ET
	Straight plug, M12x1, 4-pin, D-coded	Open end, 4-core	5 m	–	8040456	NEBC-LE4-ES-5-D12G4-ET
Inscription labels						
	For modules CPX-AP-A	Size 6x 12.5 mm, 10 frames with 24 pieces each	240	8087174	ASLR-L-X4-612-P240	
Cover cap						
	For sealing unused connections	For connection M8x1	10	177672	ISK-M8	
		For connection M12x1	10	165592	ISK-M12	

Datasheet – IO-Link master

Function

The IO-Link master has 4 IO-Link® connections Class B (type B), which enable any IO-Link® components to be linked up to the remote I/O system CPX-AP-A.

- IO-Link master
- Connection M12x1, 5-pin
- Status and error indication via LED

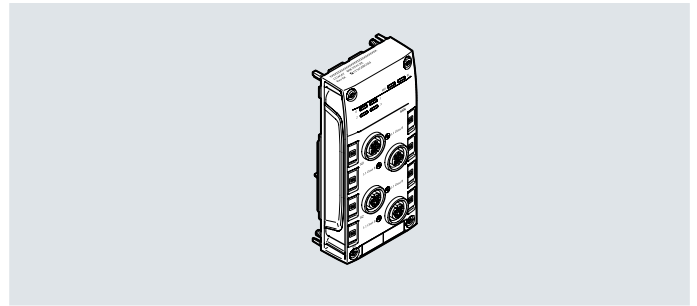

Description

The IO-Link® communication system is used to exchange serial data from decentralised function modules (devices) at the field level.

The IO-Link master provides four external IO-Link® interfaces, at each of which a device can be connected.

The connection type corresponds to a star topology, which means that only one device can be connected to each port.

The address space, master port and connected devices can be parameterised with the aid of the Festo Automation Suite.

The Festo Automation Suite can be downloaded from the Festo website.

General technical data – IO-Link master

Protocol	IO-Link®
Communication interface, protocol	AP
Max. address volume for inputs	33 bytes
Max. address volume for outputs	33 bytes
Configuration support	IODD file
Module parameters	Configuration of voltage monitoring load supply PL
Channel parameter	Diagnostics activated for IO-Link® device lost; port mode; target deviceId; target vendorID; target cycle time
Diagnostics via LED	Diagnostics per channel; diagnostics per module; power supply load; status per channel; status per module
Diagnostics via internal communication	IO-Link® event; sensor supply short circuit/overload; overvoltage electronics/sensors; overvoltage load; undervoltage electronics/sensors; undervoltage load
Internal cycle time	< 1 ms
Reverse polarity protection	Yes
Max. cable length	20 m with IO-Link® operation
Mounting position	Any

Technical data – IO-Link® interface, IO-Link master

IO-Link®, protocol version	Master V 1.1
IO-Link®, communication mode	DI, COM1. COM2. COM3.; configurable with software
IO-Link®, port class	B
IO-Link®, number of ports	4
IO-Link®, process data width OUT	8 - 128 bytes can be parameterised
IO-Link®, process data width IN	12 - 132 bytes can be parameterised
IO-Link®, communication	C/Q LED green
IO-Link®, minimum cycle time	Depending on minimally supported cycle time of connected IO-Link® device
Electrical connection for IO-Link®, connection type	4x socket
Electrical connection for IO-Link®, connection technology	M12x1, A-coded to EN 61076-2-101
Electrical connection for IO-Link®, number of pins/cores	5

Datasheet – IO-Link master

Technical data – Electrical – IO-Link® master

Nominal operating voltage DC for electronics/sensors	24 V
Nominal operating voltage DC load	24 V
Permissible voltage fluctuations, electronics/sensors	± 25%
Permissible voltage fluctuations, load	± 25%
Note on the operating voltage	SELV/PELV power supply units required; note voltage drop
Note on nominal operating voltage DC	Protected extra-low voltage to IEC 60204-1
Power failure buffering	10 ms
Intrinsic current consumption at nominal operating voltage, electronics/sensors	Typical 40 mA
Intrinsic current consumption at nominal operating voltage, load	Typical 4 mA
Max. power supply per channel	2.1 A (50 W lamp load), per channel pair
Max. total current of inputs per module	2
Max. total current outputs per module	4
Electrical isolation between the supply voltages for electronics/sensors and load/valves	Yes
Electrical isolation of outputs between channel - internal communication	Yes
Protecting inputs (short circuit)	Internal electronic fuse per module
Protection class	III
Overvoltage category	II
Pollution degree	2

Technical data – Mechanical – IO-Link master

Type of mounting	Screw-clamped
Product weight	90 g
Dimensions W x L x H	(incl. interlinking block); 50.1 mm × 107.3 mm × 57.5 mm
Grid dimension	50.1 mm

Materials – IO-Link master

Cover material	Reinforced PBT
O-ring material	FPM
Screw material	Nickel-plated steel
Note on materials	RoHS-compliant; free of halogen; free of phosphoric acid ester
LABS (PWIS) conformity	VDMA24364-B2-L

Datasheet – IO-Link master

Operating and environmental conditions – IO-Link master	
Ambient temperature	-20 ... 50 °C
Note on ambient temperature	Note ambient temperature derating to IEC 61131-2:2017
Storage temperature	-20 ... 70 °C
Corrosion resistance class CRC ¹⁾	1 - low corrosion stress
Relative humidity	5 - 95%, non-condensing
Nominal operating altitude	<= 2000 m ASL (> 79.5 kPa)
Max. setup altitude	3500 m
Note on max. setup altitude	> 2000 m ASL (< 79.5 kPa) Note ambient temperature derating to IEC 61131-2:2017
Vibration resistant	Transport application test with severity level 2 to FN 942017-4 and EN 60068-2-6
Note on vibration resistance	SG1 on DIN rail SG2 on direct mounting Transport application test with severity level 1 to FN 942017-4 and EN 60068-2-6
Shock resistance	Shock test with severity level 2 to FN 942017-5 and EN 60068-2-27
Note on shock resistance	30 g/11 ms to EN 60068-2-27 SG1 on DIN rail SG2 on direct mounting Shock test with severity level 1 to FN 942017-5 and EN 60068-2-27
Material fire test	UL94 V-0 (housing)

1) More information www.festo.com/x/topic/crc

Connection and indicator components

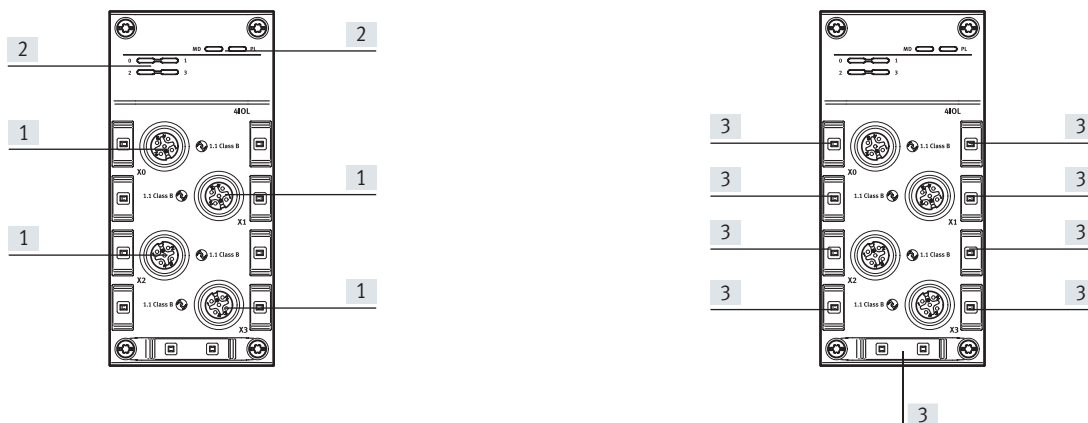





[1] IO-Link® connection

[2] LED indicators

[3] Space for inscription label

Datasheet – IO-Link master

Ordering data						
	Protocol	IO-Link®, number of ports		Part no.	Type	
	IO-Link®	4		8129114	CPX-AP-A-4IOL-M12	
Ordering data – Accessories						
	Description	Pack size	Part no.	Type		
Plug connectors for self-assembly						
	For IO-Link®	Straight plug, M12x1, 3-pin, A-coded	Insulation displacement connector	–	562027	NECU-S-M12G3-HX
		Straight plug, M12x1, 4-pin, A-coded	Insulation displacement connector	–	562028	NECU-S-M12G4-HX
		Straight plug, M12x1, 5-pin, A-coded	Screw terminal	–	8162296	NECB-S-M12G5-C2
Connecting cables						
	Modular system for a choice of connecting cables		–	8078221	NEBA... → Internet: neba	
Inscription labels						
	For modules CPX-AP-A	Size 6x 12.5 mm, 10 frames with 24 pieces each		240	8087174	ASLR-L-X4-612-P240
Cover cap						
	For sealing unused connections		For connection M12x1	10	165592	ISK-M12

Datasheet – AP interface

Function

With the end plates with AP interface, additional components with AP connection can be connected to the remote I/O system CPX-AP-A or the remote I/O system CPX-AP-A can be controlled via the AP interface.

- AP interface
- Connection M8x1, 4-pin
- Status and error indication via LED
- Voltage supply for the remote I/O system CPX-AP-A

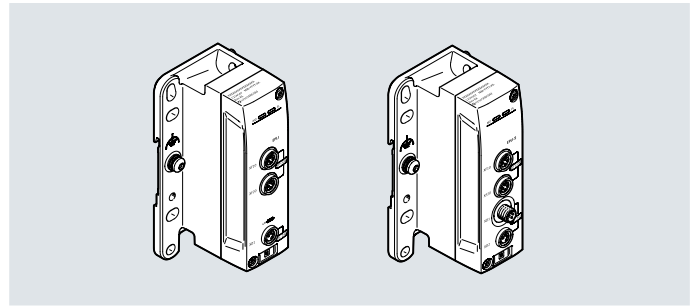

General technical data – End plates with AP control

Function	Left end plate with AP connection and power output	Left end plate with AP connection, power supply, power output
Diagnostics via LED	Diagnostics per module; power supply for electronics/sensors; power supply for load	
Diagnostics via internal communication	Load switch-off Communication error Short circuit/overload Power OUT PL Short circuit/overload Power OUT PS Overvoltage electronics/sensors Overvoltage load Undervoltage electronics/sensors Undervoltage load	Load switch-off Communication error Overvoltage electronics/sensors Overvoltage load Undervoltage electronics/sensors Undervoltage load
Reverse polarity protection	Yes	
Max. cable length	50 m system communication	
Mounting position	Any, on DIN rail: horizontal	

Technical data – AP interface – End plates with AP control

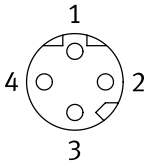

Communication interface, function	System communication XF10 IN / XF20 OUT
Communication interface, connection type	2 x socket
Communication interface, connection technology	M8x1, D-coded to EN 61076-2-114
Communication interface, number of pins/cores	4
Communication interface, protocol	AP
Communication interface, shielding	Yes

Datasheet – AP interface

Technical data – Power supply interface – End plates with AP control

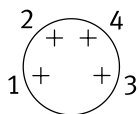

- 1 Operating voltage 24 V electronics and sensors
- 2 Operating voltage 0 V load voltage supply
- 3 Operating voltage 0 V electronics and sensors
- 4 Operating voltage 24 V load voltage supply

Function	Left end plate with AP connection, power supply, power output
Power supply, function	Incoming electronics/sensors and load
Power supply, connection type	Plug
Power supply, connection technology	M8x1, A-coded to EN 61076-2-104
Power supply, number of pins/cores	4
Power supply, conductor cross-section	0.5 mm ²

Technical data – Interface – Power transmission – End plates with AP control

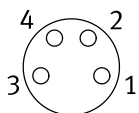

- 1 Operating voltage 24 V electronics and sensors
- 2 Operating voltage 0 V load voltage supply
- 3 Operating voltage 0 V electronics and sensors
- 4 Operating voltage 24 V load voltage supply

Function	Left end plate with AP connection and power output	Left end plate with AP connection, power supply, power output
Power transmission, function	Outgoing electronics/sensors and load	
Power transmission, connection type	Socket	
Power transmission, connection technology	M8x1, A-coded to EN 61076-2-104	
Nominal current	–	4 A
Max. power supply	–	2 x 4 A (external fuse required)
Behaviour after end of overload of the sensor supply	No automatic return with overload at Power OUT	–
Behaviour after end of overload of the outputs	No automatic return with overload at Power OUT	–

Datasheet – AP interface

Technical data – Electrical – End plates with AP control

Function	Left end plate with AP connection and power output	Left end plate with AP connection, power supply, power output
Nominal operating voltage DC for electronics/sensors	24 V	
Permissible voltage fluctuations, electronics/sensors	± 25%	
Nominal operating voltage DC load	24 V	
Permissible voltage fluctuations, load	± 25%	
Electrical isolation between the supply voltages for electronics/sensors and load/valves	Yes	
Note on nominal operating voltage DC	Protected extra-low voltage to IEC 60204-1	2x24 V [XD1,PS,PL] Protected extra-low voltage to IEC 60204-1
Note on the operating voltage	SELV/PELV power supply units required Note voltage drop	
Power failure buffering	10 ms	
Intrinsic current consumption at nominal operating voltage, electronics/sensors	Typical 45 mA	Typical 41 mA
Intrinsic current consumption at nominal operating voltage, load	Typical 11 mA	Typical 3 mA
Protection class	III	
Overvoltage category	II	
Pollution degree	2	
Protection (short circuit)	Yes, Power Out PS+PL	–

Technical data – Mechanical – End plates with AP control

Function	Left end plate with AP connection and power output	Left end plate with AP connection, power supply, power output
Type of mounting	Direct mounting via through-hole On DIN rail with accessories On mounting frame With through-hole for M5 screw With through-hole for M6 screw	
Product weight	245 g	256 g
Dimensions W x L x H	(installation dimensions) 48.4 mm x 117.2 mm x 57.5 mm	(installation dimensions) 48.4 mm x 117.2 mm x 61.5 mm

Materials – End plates with AP control

Housing material	Coated die-cast aluminium
Cover material	Reinforced PBT
O-ring material	FPM
Sealing material	Polyurethane foam
Screw material	Nickel-plated steel; galvanised steel
Note on materials	RoHS-compliant; free of halogen; free of phosphoric acid ester
LABS (PWIS) conformity	VDMA24364-B2-L

Datasheet – AP interface

Operating and environmental conditions – End plates with AP control	
Ambient temperature	-20 ... 50 °C
Note on ambient temperature	Note ambient temperature derating to IEC 61131-2:2017
Storage temperature	-20 ... 70 °C
Corrosion resistance class CRC ¹⁾	1 - low corrosion stress
Relative humidity	5 - 95%, non-condensing
Nominal operating altitude	<= 2000 m ASL (> 79.5 kPa)
Max. setup altitude	3,500 m
Note on max. setup altitude	> 2000 m ASL (< 79.5 kPa) Note ambient temperature derating to IEC 61131-2:2017
Vibration resistant	Transport application test with severity level 2 to FN 942017-4 and EN 60068-2-6
Note on vibration resistance	SG1 on DIN rail SG2 on direct mounting Transport application test with severity level 1 to FN 942017-4 and EN 60068-2-6
Shock resistance	Shock test with severity level 2 to FN 942017-5 and EN 60068-2-27
Note on shock resistance	30 g/11 ms to EN 60068-2-27 SG1 on DIN rail SG2 on direct mounting Shock test with severity level 1 to FN 942017-5 and EN 60068-2-27
Material fire test	UL94 V-0 (housing)

1) More information www.festo.com/x/topic/crc

Datasheet – AP interface

Connection and indicator components – Left end plate left with AP connection and power output

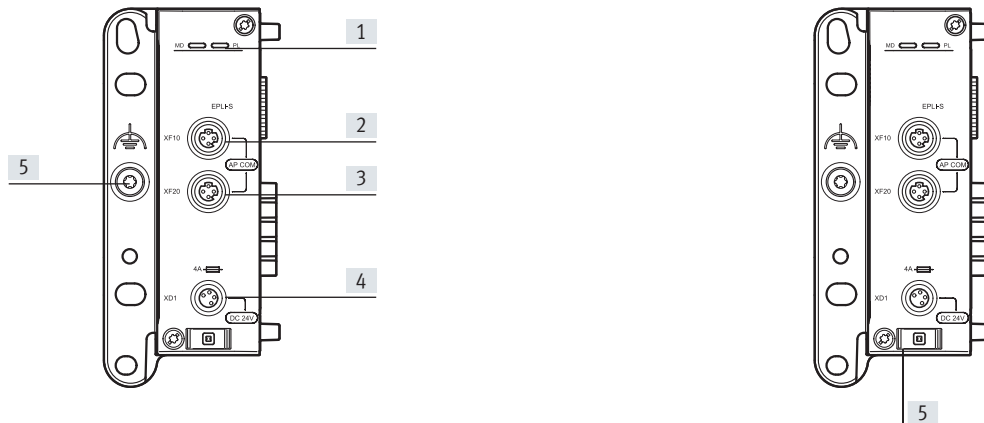



- | | | |
|--|---|---------------------------------|
| [1] LED indicators | [2] Communication interface, system communication XF10 IN | [5] Space for inscription label |
| [2] Communication interface, system communication XF20 OUT | [4] Power transmission | |
| | [5] Earthing connection | |

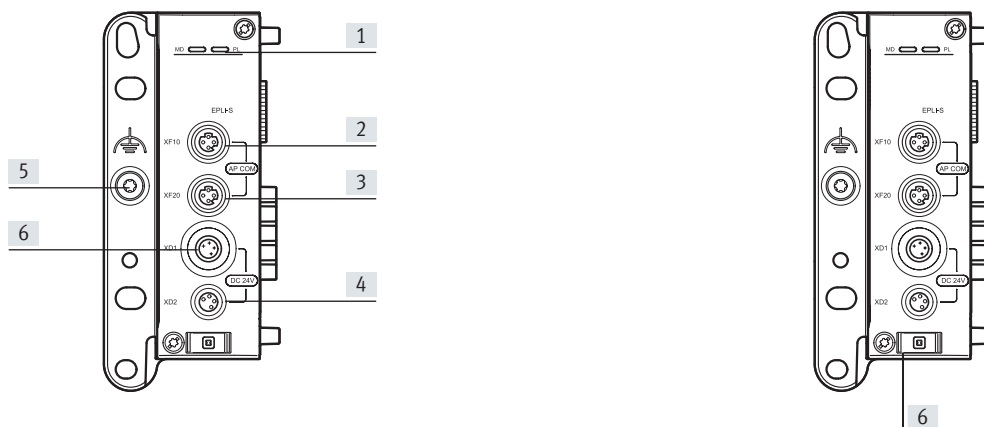



Connection and indicator components – Left end plate with AP connection, power supply, power output



- | | | |
|--|-------------------------|---------------------------------|
| [1] LED indicators | [4] Power transmission | [6] Space for inscription label |
| [2] AP interface | [5] Earthing connection | |
| [2] Communication interface, system communication XF10 IN | [6] Power supply | |
| [2] Communication interface, system communication XF20 OUT | | |

Datasheet – AP interface

Ordering data				
	Function	Product weight [g]	Part no.	Type
	Left end plate with AP connection and power output	245	8129250	CPX-AP-A-EPLI
	Left end plate with AP connection, power supply, power output	256	8129249	CPX-AP-A-EPLI-S

Ordering data – Accessories				
	Description	Pack size	Part no.	Type
Inscription labels				
	For modules CPX-AP-A	Size 6x 12.5 mm, 10 frames with 24 pieces each	240	8087174 ASLR-L-X4-612-P240
Cover cap				
	For sealing unused connections	For connection M8x1	10	177672 ISK-M8
Mounting				
	For DIN rail mounting	–	8159824	CAFM-X5-H
	For mounting on support system with valve terminal VTSA/VTSA-F/VTSA-F-CB	–	8130845	CAFM-X5-K

Datasheet – Digital input modules

Function

Digital input modules allow electric sensors to be connected according to IEC 61131-2 type 3 (inductive, capacitive) with an operating voltage of 24 V DC.

- Input modules for 24 V DC operating voltage
- Connection M8x1, 3-pin
- Connection M12x1, 5-pin
- Spring-loaded terminal connection
- Status and error indication via LED
- Electronic fuse per channel

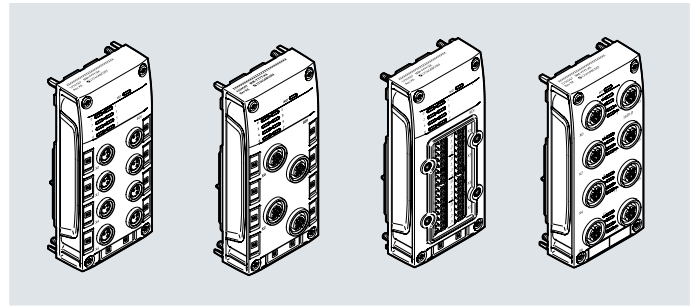

General technical data – Input modules

Electrical connection for input, connection type	8x socket M8x1, A-coded	4x socket M12x1, A-coded	8x terminal strip	8x socket M12x1, A-coded
Communication interface, protocol	AP			
Number of inputs	8	8	8	16
Max. address volume for inputs	1 bytes	1 bytes	1 bytes	2 bytes
Channel parameter	Input debounce time			
Diagnostics via LED	Diagnostics per module; status per channel			Diagnostics per channel; status per channel
Diagnostics via internal communication	Communication errors; sensor supply short circuit/overload; overvoltage electronics/sensors; overvoltage load; undervoltage electronics/sensors			
Reverse polarity protection	Yes			
Max. cable length	30 m inputs			
Mounting position	Any			

Technical data – Interfaces – Input modules

Electrical connection for input, connection type	8x socket M8x1, A-coded	4x socket M12x1, A-coded	8x terminal strip	8x socket M12x1, A-coded
Electrical connection for input, function	Digital input			
Electrical connection for input, connection technology	M8x1, A-coded to EN 61076-2-104	M12x1 A-coded to EN 61076-2-101	Spring-loaded terminal	M12x1 A-coded to EN 61076-2-101
Electrical connection for input, number of pins/cores	3	5	–	5
Electrical connection for input, conductor cross-section	–	–	0.25 ... 1.5 mm ²	–
Electrical connection for input, conductor cross-section AWG	–	–	AWG24 ... AWG16	–
Electrical connection for input, note on conductor cross-section	–	–	0.25 ... 1.5 mm ² for flexible conductor with wire ferrules and rigid conductors 0.13 ... 1.5 mm ² for flexible conductors without wire ferrules	–
Switching logic at inputs	PNP (positive switching) 2-wire sensors to IEC 61131-2 3-wire sensors to IEC 61131-2			
Characteristic curve of inputs	To IEC 61131-2, type 3			
Switching level	Signal 0: ≤ 5 V Signal 1: ≥ 11 V			
Input debounce time	0.1 ms; 3 ms (standard); 10 ms; 20 ms			

Datasheet – Digital input modules

Technical data – Electrical – Input modules				
Electrical connection for input, connection type	8x socket M8x1, A-coded	4x socket M12x1, A-coded	8x terminal strip	8x socket M12x1, A-coded
Nominal operating voltage DC for electronics/sensors	24 V			
Permissible voltage fluctuations, electronics/sensors	± 25%			
Note on the operating voltage	SELV/PELV power supply units required; note voltage drop			
Note on nominal operating voltage DC	Protected extra-low voltage to IEC 60204-1			
Power failure buffering	10 ms			
Intrinsic current consumption at nominal operating voltage, electronics/sensors	Typical 40 mA			
Max. power supply per channel	0.5 A			
Max. total current of inputs per module	1.8 A			4 A
Electrical isolation of inputs between channels	No			
Electrical isolation of inputs between channel - internal communication	Yes			
Protecting inputs (short circuit)	Internal electronic fuse per module			Internal electronic fuse per socket
Behaviour after end of overload of the sensor supply	Automatic return			
Protection class	III			
Overvoltage category	II			
Pollution degree	2			

Technical data – Mechanical – Input modules				
Electrical connection for input, connection type	8x socket M8x1, A-coded	4x socket M12x1, A-coded	8x terminal strip	8x socket M12x1, A-coded
Type of mounting	Screw-clamped			
Product weight	83 g	87 g	93	96 g
Dimensions W x L x H	(incl. interlinking block); 50.1 mm × 107.3 mm × 57.5 mm			
Grid dimension	50.1 mm			

Materials – Input modules	
Cover material	Reinforced PBT
O-ring material	FPM
Screw material	Nickel-plated steel
Note on materials	RoHS-compliant; free of halogen; free of phosphoric acid ester
LABS (PWIS) conformity	VDMA24364-B2-L

Datasheet – Digital input modules

Operating and environmental conditions – Input modules	
Ambient temperature	-20 ... 50 °C
Note on ambient temperature	Note ambient temperature derating to IEC 61131-2:2017
Storage temperature	-20 ... 70 °C
Corrosion resistance class CRC ¹⁾	1 - low corrosion stress
Relative humidity	5 - 95%, non-condensing
Nominal operating altitude	<= 2000 m ASL (> 79.5 kPa)
Max. setup altitude	3500 m
Note on max. setup altitude	> 2000 m ASL (< 79.5 kPa) Note ambient temperature derating to IEC 61131-2:2017
Vibration resistant	Transport application test with severity level 2 to FN 942017-4 and EN 60068-2-6
Note on vibration resistance	SG1 on DIN rail SG2 on direct mounting Transport application test with severity level 1 to FN 942017-4 and EN 60068-2-6
Shock resistance	Shock test with severity level 2 to FN 942017-5 and EN 60068-2-27
Note on shock resistance	30 g/11 ms to EN 60068-2-27 SG1 on DIN rail SG2 on direct mounting Shock test with severity level 1 to FN 942017-5 and EN 60068-2-27
Material fire test	UL94 V-0 (housing)

1) More information www.festo.com/x/topic/crc

Datasheet – Digital input modules

Connection and indicator components – Module with 8 inputs, 8x socket M8x1, A-coded

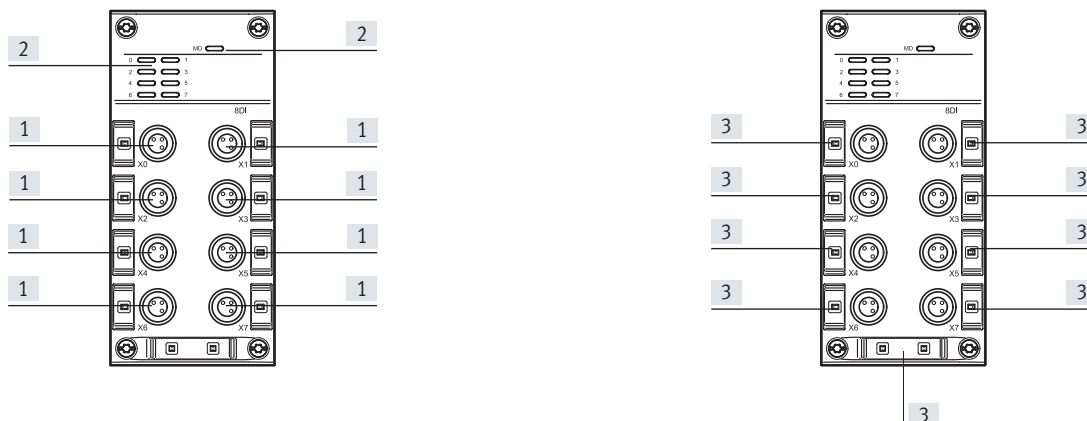

[1] Electrical connection, inputs [2] LED indicators [3] Space for inscription label

Connection and indicator components – Module with 8 inputs, 4x socket M12x1, A-coded

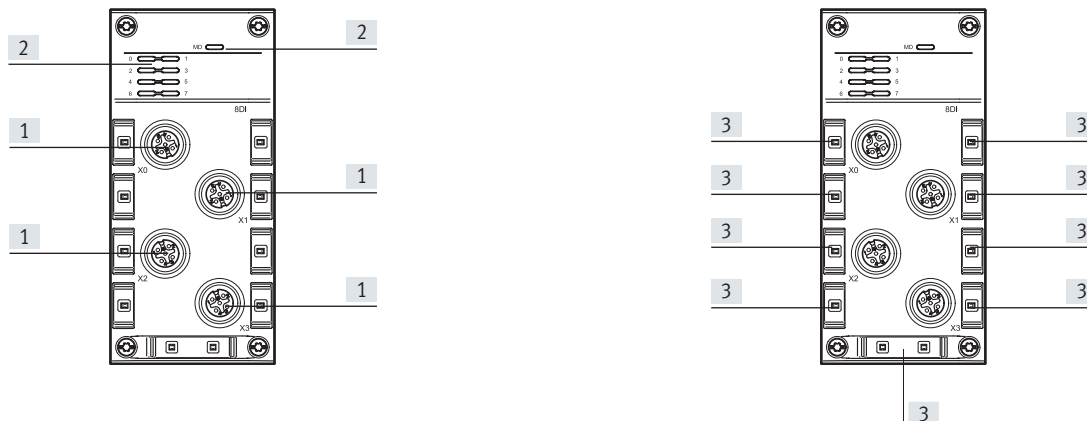

[1] Electrical connection, inputs [2] LED indicators [3] Space for inscription label

Connection and indicator components – Module with 8 inputs, 8 terminal strips

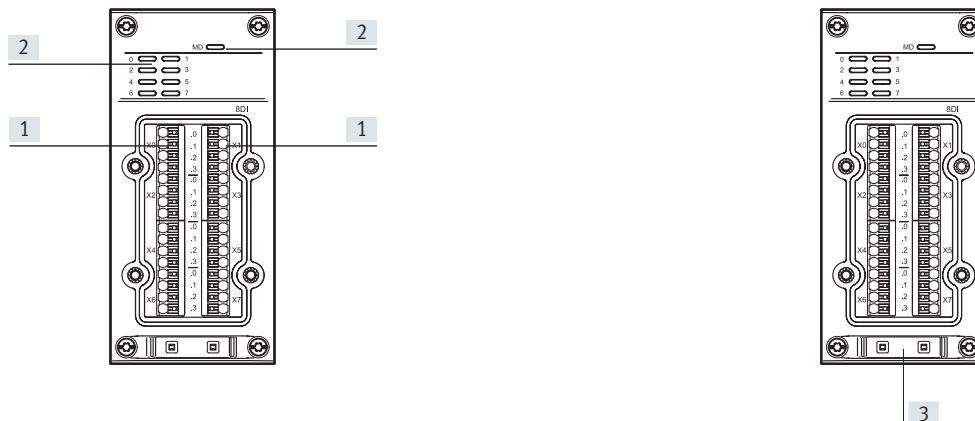

[1] Electrical connection, inputs [2] LED indicators [3] Space for inscription label

Datasheet – Digital input modules

Connection and indicator components – Module with 16 inputs, 8x socket M12x1, A-coded

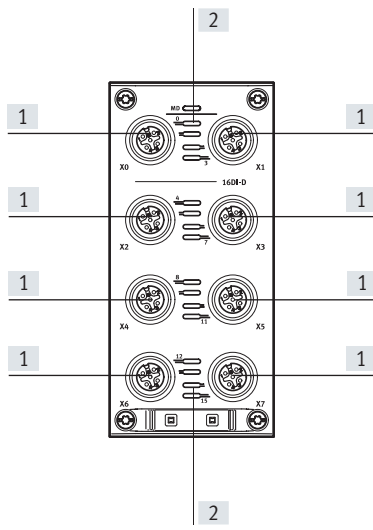

[1] Electrical connection, inputs

[2] LED indicators

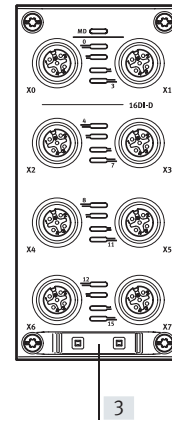

[3] Space for inscription label

Datasheet – Digital input modules

Pin assignment – Sensor connections – Socket M8x1, A-coded

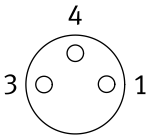
Terminal assignment	Pin	Assignment	Description
	1	24 V	Operating voltage 24 V
	3	0 V	Operating voltage 0 V
	4	Ix*	Input signal

* Ix = Input x

Pin assignment – Sensor connections socket M12x1 A-coded

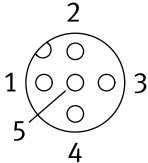
Terminal assignment	Pin	Assignment	Description
	1	24 V	Operating voltage 24 V
	2	Ix+1*	Input signal
	3	0 V	Operating voltage 0 V
	4	Ix*	Input signal
	5	FE	Functional earth

* Ix = Input x

Pin assignment – Sensor connections – Spring-loaded terminal

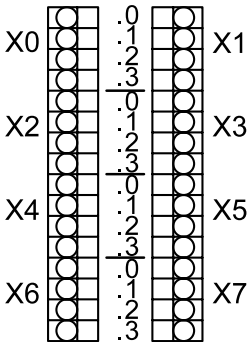
Terminal assignment	Pin	Assignment	Description
	.0	24 V	Operating voltage 24 V
	.1	0 V	Operating voltage 0 V
	.2	Ix*	Input signal
	.3	FE	Functional earth

* Ix = Input x

Datasheet – Digital input modules



Ordering data		Number of inputs	Electrical connection		Part no.	Type
	Digital input module	8	8x socket M8x1, A-coded	3-pin	8129103	CPX-AP-A-8DI-M8-3P
			4x socket M12x1, A-coded	5-pin	8129109	CPX-AP-A-8DI-M12-5P
			8x terminal strip	–	8129106	CPX-AP-A-8DI-PI
		16	8x socket M12x1, A-coded	5-pin	8129112	CPX-AP-A-16DI-D-M12-5P

Ordering data – Accessories						
Description			Pack size	Part no.	Type	
Plug connectors for self-assembly						
	Straight plug, M8x1, 3-pin, A-coded	Screw terminal	Cable diameter 2.1 ... 5 mm	–	8162298	NECB-S-M8G3-C2
		Insulation displacement connector	Connection cross-section 0.1 ... 0.14 mm ²	–	564945	NECU-S-M8G3-HX-Q3
			Connection cross-section 0.14 ... 0.34 mm ²	–	562024	NECU-S-M8G3-HX
	Straight plug, M12x1, 5-pin, A-coded	Screw terminal	Cable	–	8162296	NECB-S-M12G5-C2
			2x cable	–	8162297	NECB-S-M12G5-C2-D
Straight plug, M12x1, 4-pin, A-coded	Insulation displacement connector	–	–	562028	NECU-S-M12G4-HX	

Distributor						
	Straight plug, M12x1, 4-pin, A-coded	2x socket, M8 A-coded, 3-pin	2.5 m	–	8005301	NEDY-L2R1-V1-M8G3-U-M12G4-2.5R
			5 m	–	8005302	NEDY-L2R1-V1-M8G3-U-M12G4-5R
			0.3 m + 2.5 m	–	8032309	NEDY-L2R1-V1-M8G3-U-0.3L-M12G4-2.5R
			0.3 m + 5 m	–	8035484	NEDY-L2R1-V1-M8G3-U-0.3L-M12G4-5R
		2x socket, M12 A-coded, 5-pin	2.5 m	–	8005305	NEDY-L2R1-V1-M12G5-U-M12G4-2.5R
			5 m	–	8005306	NEDY-L2R1-V1-M12G5-U-M12G4-5R
			0.3 m + 2.5 m	–	8035775	NEDY-L2R1-V1-M12G5-U-0.3L-M12G4-2.5R
			0.3 m + 5 m	–	8035776	NEDY-L2R1-V1-M12G5-U-0.3L-M12G4-5R
	Modular system for all types of sensor/actuator distributor			–	–	NEDY-...

Connecting cables						
	Modular system for a choice of connecting cables			–	8078221	NEBA-... → Internet: neba

Inscription labels						
	For modules CPX-AP-A	Size 6x 12.5 mm, 10 frames with 24 pieces each	240		8087174	ASLR-L-X4-612-P240

Covering						
	Cover cap for sealing unused connections	For connection M8x1	10	177672	ISK-M8	
		For connection M12x1	10	165592	ISK-M12	
	Cover for terminal strip (IP65, IP67)	<ul style="list-style-type: none"> 8 cable through-feeds M9 1 cable through-feed for multi-pin plug 		538219	AK-8KL	
	Fittings kit for covering hood			538220	VG-K-M9	

Datasheet – Analogue input modules

Function

Analogue input modules enable different analogue sensors to be connected to the remote I/O system CPX-AP-A. The input module can be parameterised for detecting different data (voltage, current, resistance, temperature).

- Input modules for 24 V DC operating voltage
- Connection M12x1, 5-pin
- Status and error indication via LED
- Electronic fuse per channel

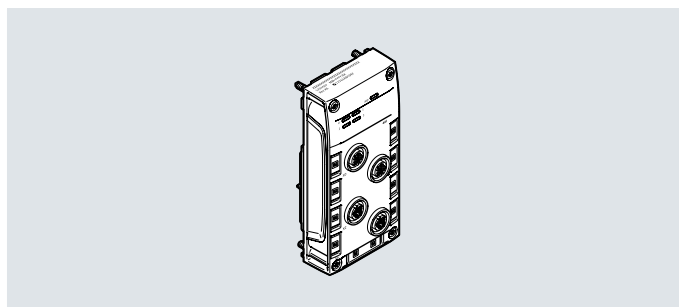

General technical data – Input modules

Communication interface, protocol	AP
Number of inputs	4
Max. address volume for inputs	8 bytes
Channel parameter	Measured value smoothing; signal range; lower/upper limit value; activation of linear scaling; unit for temperature measurement; hysteresis for measured value monitoring
Diagnostics via LED	Diagnostics per module; status per channel
Diagnostics via internal communication	Wire break; communication errors; short circuit/overload; parameter error; parameterisation error; overload analogue inputs; upper limit value not observed; overvoltage electronics/sensors; underflow/overflow; lower limit value not observed; undervoltage electronics/sensors
Reverse polarity protection	Yes
Max. cable length	30 m inputs
Mounting position	Any

Technical data – Interfaces – Input modules

Measured variable	Voltage; current; temperature; resistance
Note on the measured variable	Temperature: PT100 and NI100 supported
Electrical connection for input, function	Analogue input
Electrical connection for input, connection technology	M12x1 A-coded to EN 61076-2-101
Electrical connection for input, connection type	4x socket
Electrical connection for input, number of pins/cores	5
Data format	15 bit + prefix; linear scaling
Signal range	-10 - 10 V -5 - 5 V 0 - 10 V 1 - 5 V 0 - 20 mA 4 - 20 mA 0 - 500 Ohm
Repetition accuracy	±0.025% at 25 °C
Basic error limit at 25 °C	±0.1% for voltage ±0.1% for current ±0.2% for resistor ±0.4% for temperature
Operating error limit related to the ambient temperature range	±0.15% for voltage ±0.15% for current ±0.35% for resistance ±0.9% for temperature

Datasheet – Analogue input modules

Technical data – Electrical – Input modules

Nominal operating voltage DC for electronics/sensors	24 V
Permissible voltage fluctuations, electronics/sensors	± 25%
Note on the operating voltage	SELV/PELV power supply units required; note voltage drop
Note on nominal operating voltage DC	Protected extra-low voltage to IEC 60204-1
Power failure buffering	10 ms
Intrinsic current consumption at nominal operating voltage, electronics/sensors	Typical 34 mA
Max. power supply per channel	0.5 A
Max. total current of inputs per module	1 A
Electrical isolation of inputs between channels	No
Electrical isolation of inputs between channel - internal communication	Yes
Protecting inputs (short circuit)	Internal electronic fuse per module
Behaviour after end of overload of the sensor supply	Automatic return
Protection class	III
Overvoltage category	II
Pollution degree	2

Technical data – Mechanical – Input modules

Type of mounting	Screw-clamped
Product weight	121 g
Dimensions W x L x H	(incl. interlinking block); 50.1 mm × 107.3 mm × 57.5 mm
Grid dimension	50.1 mm

Materials – Input modules

Cover material	Reinforced PBT
O-ring material	FPM
Threaded sleeve material	High-alloy stainless steel
Screw material	Nickel-plated steel
Note on materials	RoHS-compliant; free of halogen; free of phosphoric acid ester
LABS (PWIS) conformity	VDMA24364-B2-L

Datasheet – Analogue input modules

Operating and environmental conditions – Input modules

Ambient temperature	-20 ... 50 °C
Storage temperature	-20 ... 70 °C
Note on ambient temperature	Note ambient temperature derating to IEC 61131-2:2017
Corrosion resistance class CRC ¹⁾	1 - low corrosion stress
Relative humidity	5 - 95%, non-condensing
Nominal operating altitude	<= 2000 m ASL (> 79.5 kPa)
Max. setup altitude	3,500 m
Note on max. setup altitude	> 2000 m ASL (< 79.5 kPa) Note ambient temperature derating to IEC 61131-2:2017
Vibration resistant	Transport application test with severity level 2 to FN 942017-4 and EN 60068-2-6
Note on vibration resistance	SG1 on DIN rail SG2 on direct mounting Transport application test with severity level 1 to FN 942017-4 and EN 60068-2-6
Shock resistance	Shock test with severity level 2 to FN 942017-5 and EN 60068-2-27
Note on shock resistance	30 g/11 ms to EN 60068-2-27 SG1 on DIN rail SG2 on direct mounting Shock test with severity level 1 to FN 942017-5 and EN 60068-2-27
Material fire test	UL94 V-0 (housing)

1) More information www.festo.com/x/topic/crc

Connection and indicator components – Module with 4 inputs, 4x socket M12x1, A-coded

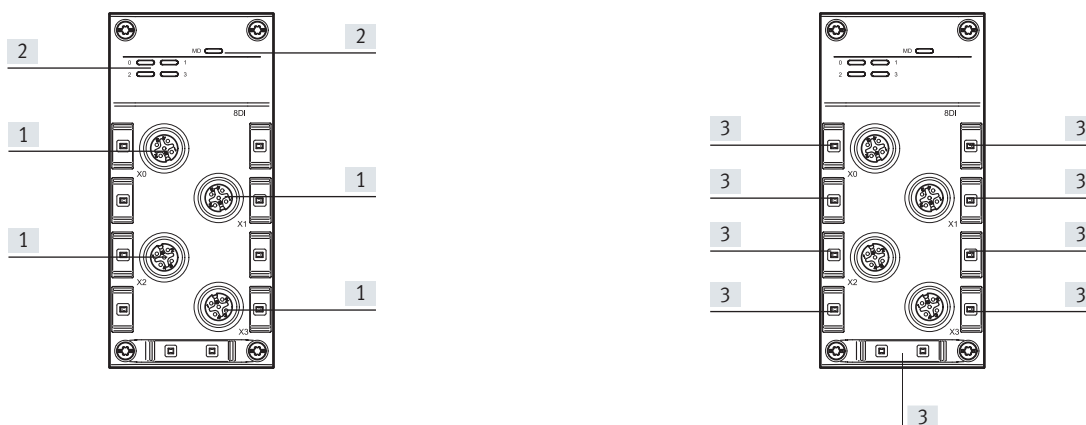





[1] Electrical connection, inputs

[2] LED indicators

[3] Space for inscription label

Datasheet – Analogue input modules

Ordering data						
		Number of inputs	Electrical connection		Part no.	Type
	Analogue input module	4	4x socket M12x1, A-coded	5-pin	8129113	CPX-AP-A-4AI-U-I-RTD-M12
Ordering data – Accessories						
	Description		Pack size		Part no.	Type
Plug connectors for self-assembly						
	Straight plug, M12x1, 5-pin, A-coded	Screw terminal	Cable	–	8162296	NECB-S-M12G5-C2
			2x cable	–	8162297	NECB-S-M12G5-C2-D
Connecting cables						
	Modular system for a choice of connecting cables			–	8078221	NEBA-... → Internet: neba
Inscription labels						
	For modules CPX-AP-A	Size 6x 12.5 mm, 10 frames with 24 pieces each	240		8087174	ASLR-L-X4-612-P240
Covering						
	Cover cap for sealing unused connections	For connection M12x1	10		165592	ISK-M12

Datasheet – Digital output modules

Function

Digital output modules allow electrical consumers to be connected according to IEC 61131-2 type 0.5 or IEC 61131-2 type 2 (valves, contactors or indicator components) with an operating voltage of 24 V DC.

- Output modules for 24 V DC operating voltage
- Connection M8x1, 3-pin
- Connection M12x1, 5-pin
- Spring-loaded terminal connection
- Status and error indication via LED
- Electronic protection against short circuit or overload with automatic resetting
- Slow response; possible short-term increase in current requirement

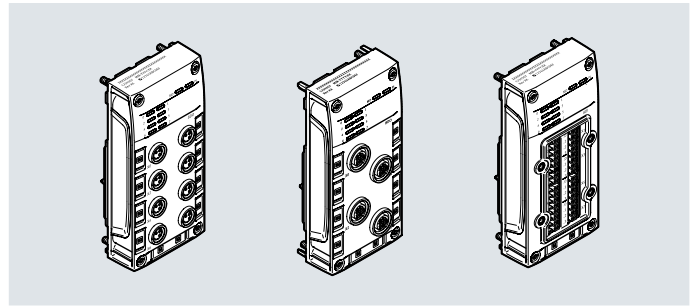

General technical data – Output modules

Communication interface, protocol	AP
Number of outputs	8
Max. address volume for outputs	1 bytes
Module parameters	Configuration of voltage monitoring of load supply PL; behaviour after short circuit/overload at output
Diagnostics via LED	Diagnostics per channel; diagnostics per module; power supply load; status per channel
Diagnostics via internal communication	Switch-off load supply; communication error; short circuit/overload output signal; overvoltage electronics/sensors; overvoltage load; undervoltage electronics/sensors; undervoltage load
Reverse polarity protection	Yes
Max. cable length	30 m outputs
Mounting position	Any

Technical data – Interfaces – Output modules

Electrical connection for output, connection type	8x socket M8x1, A-coded	4x socket M12x1, A-coded		8x terminal strip
Max. power supply per channel	0.5 A	0.5 A	2 A	0.5 A
Electrical connection for output, function	Digital output			
Electrical connection for output, connection type	8x socket	4x socket	4x socket	8x terminal strip
Electrical connection for output, connection technology	M8x1, A-coded to EN 61076-2-104	M12x1 A-coded to EN 61076-2-101	M12x1 A-coded to EN 61076-2-101	Spring-loaded terminal
Electrical connection for output, number of pins/cores	3	5	5	4
Electrical connection for output, conductor cross-section	–	–	–	0.25 ... 1.5 mm ²
Electrical connection for output, conductor cross-section AWG	–	–	–	AWG24 ... AWG16
Electrical connection for output, note on conductor cross-section	–	–	–	0.13 ... 1.5 mm ² for flexible conductors without wire ferrules
Switching logic at outputs	PNP (positive switching)			
Characteristic curve of outputs	To IEC 61131-2, type 0.5	To IEC 61131-2, type 0.5	To IEC 61131-2, type 2	To IEC 61131-2, type 0.5
Output delay with resistive load	Signal change 0->1: < 200 µs Signal change 1->0: < 200 µs			

Datasheet – Digital output modules

Technical data – Electrical – Output modules				
Electrical connection for output, connection type	8x socket M8x1, A-coded	4x socket M12x1, A-coded		8x terminal strip
Max. power supply per channel	0.5 A	0.5 A	2 A	0.5 A
Nominal operating voltage DC for electronics/sensors	24 V			
Permissible voltage fluctuations, electronics/sensors	± 25%			
Nominal operating voltage DC load	24 V			
Permissible voltage fluctuations, load	± 25%			
Note on the operating voltage	SELV/PELV power supply units required; note voltage drop			
Note on nominal operating voltage DC	Protected extra-low voltage to IEC 60204-1			
Power failure buffering	10 ms			
Intrinsic current consumption at nominal operating voltage, electronics/sensors	Typical 40 mA			
Intrinsic current consumption at nominal operating voltage, load	Typical 5 mA			
Max. power supply per channel	0.5 A	0.5 A	2 A	0.5 A
Max. total current outputs per module	4 A	4 A	9 A	4 A
Electrical isolation between the supply voltages for electronics/sensors and load/valves	Yes			
Electrical isolation of outputs between channels	No			
Electrical isolation of outputs between channel - internal communication	Yes			
Protecting outputs (short circuit)	Internal electronic fuse per channel			
Behaviour after end of overload of the outputs	No automatic return			
Protection class	III			
Overvoltage category	II			
Pollution degree	2			

Technical data – Mechanical – Output modules				
Electrical connection for output, connection type	8x socket M8x1, A-coded	4x socket M12x1, A-coded		8x terminal strip
Max. power supply per channel	0.5 A	0.5 A	2 A	0.5 A
Type of mounting	Screw-clamped			
Product weight	88 g	91 g	93 g	98 g
Dimensions W x L x H	(incl. interlinking block); 50.1 mm × 107.3 mm × 57.5 mm			
Grid dimension	50.1 mm			

Materials – Output modules	
Cover material	Reinforced PBT
O-ring material	FPM
Screw material	Nickel-plated steel
Note on materials	RoHS-compliant; free of halogen; free of phosphoric acid ester
LABS (PWIS) conformity	VDMA24364-B2-L

Datasheet – Digital output modules

Operating and environmental conditions – Output modules

Ambient temperature	-20 ... 50 °C
Note on ambient temperature	Note ambient temperature derating to IEC 61131-2:2017
Storage temperature	-20 ... 70 °C
Corrosion resistance class CRC ¹⁾	1 - low corrosion stress
Relative humidity	5 - 95%, non-condensing
Nominal operating altitude	<= 2000 m ASL (> 79.5 kPa)
Max. setup altitude	3500 m
Note on max. setup altitude	> 2000 m ASL (< 79.5 kPa) Note ambient temperature derating to IEC 61131-2:2017
Vibration resistant	Transport application test with severity level 2 to FN 942017-4 and EN 60068-2-6
Note on vibration resistance	SG1 on DIN rail SG2 on direct mounting Transport application test with severity level 1 to FN 942017-4 and EN 60068-2-6
Shock resistance	Shock test with severity level 2 to FN 942017-5 and EN 60068-2-27
Note on shock resistance	30 g/11 ms to EN 60068-2-27 SG1 on DIN rail SG2 on direct mounting Shock test with severity level 1 to FN 942017-5 and EN 60068-2-27
Material fire test	UL94 V-0 (housing)

1) More information www.festo.com/x/topic/crc

Connection and indicator components – Module with 8 outputs, 8x socket M8x1, A-coded

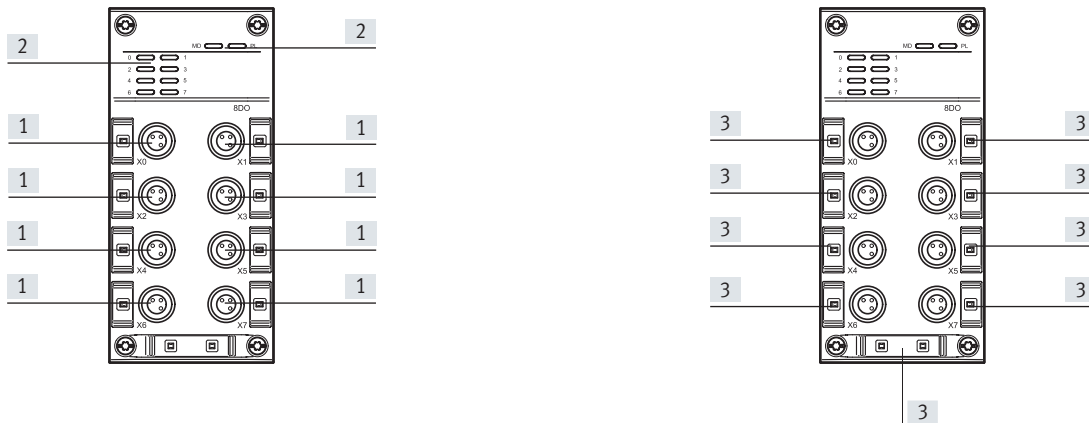

[1] Electrical connection, outputs

[2] LED indicators

[3] Space for inscription label

Connection and indicator components – Module with 8 outputs, 4x socket M12x1, A-coded



[1] Electrical connection, outputs

[2] LED indicators

[3] Space for inscription label

Datasheet – Digital output modules

Connection and indicator components – Module with 8 outputs, 8 terminal strips

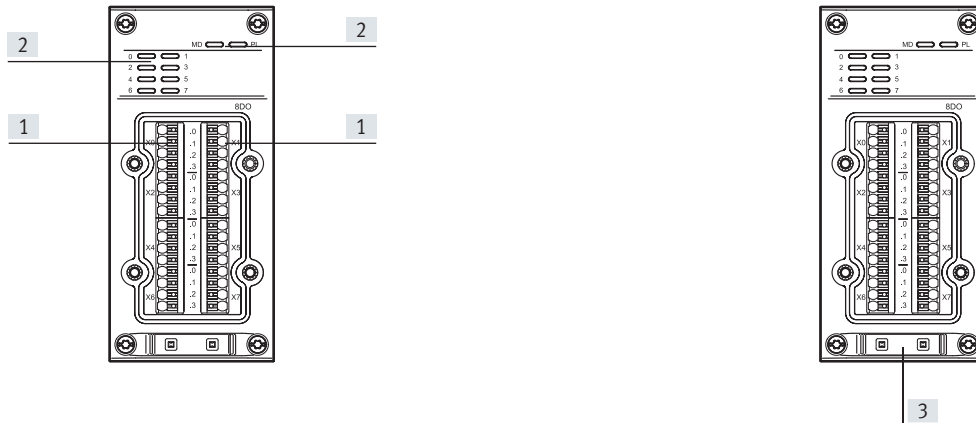

[1] Electrical connection, outputs [2] LED indicators [3] Space for inscription label

Pin assignment – Outputs – Socket M8x1, A-coded

Terminal assignment	Pin	Assignment	Description
	1	n.c.	Not connected
	3	0 V	Operating voltage 0 V
	4	Ox*	Output signal

* Ox = Output x

Pin assignment – Outputs – Socket M12x1, A-coded

Terminal assignment	Pin	Assignment	Description
	1	n.c.	Not connected
	2	Ox+1*	Output signal
	3	0 V	Operating voltage 0 V
	4	Ox*	Output signal
	5	FE	Functional earth

* Ox = Output x

Pin assignment – Outputs – Spring-loaded terminal

Terminal assignment	Pin	Assignment	Description
	.0	Ox*	Output signal
	.1	0 V	Operating voltage 0 V
	.2	FE	Functional earth
	.3	n.c.	Not connected

* Ox = Output x





Datasheet – Digital output modules

Ordering data							
		Number of outputs	Electrical connection		Max. power supply per channel	Part no.	Type
	Digital output module	8	8x socket M8x1, A-coded	3-pin	0.5 A	8129104	CPX-AP-A-8DO-M8-3P
			4x socket M12x1, A-coded	5-pin	0.5 A	8129110	CPX-AP-A-8DO-M12-5P
					2 A	8175409	CPX-AP-A-8HDO-M12-5P
			8x terminal strip	4-pin	0.5 A	8129107	CPX-AP-A-8DO-PI

Ordering data – Accessories						
	Description		Pack size	Part no.	Type	
Plug connectors for self-assembly						
	Straight plug, M8x1, 3-pin, A-coded	Screw terminal	Cable diameter 2.1 ... 5 mm	–	8162298	NECB-S-M8G3-C2
		Insulation displacement connector	Connection cross-section 0.1 ... 0.14 mm ²	–	564945	NECU-S-M8G3-HX-Q3
			Connection cross-section 0.14 ... 0.34 mm ²	–	562024	NECU-S-M8G3-HX
	Straight plug, M12x1, 5-pin, A-coded	Screw terminal	Cable	–	8162296	NECB-S-M12G5-C2
			2x cable	–	8162297	NECB-S-M12G5-C2-D
Straight plug, M12x1, 4-pin, A-coded	Insulation displacement connector	–	–	562028	NECU-S-M12G4-HX	

Distributor						
	Straight plug, M12x1, 4-pin, A-coded	2x socket, M8 A-coded, 3-pin	2.5 m	–	8005301	NEDY-L2R1-V1-M8G3-U-M12G4-2.5R
			5 m	–	8005302	NEDY-L2R1-V1-M8G3-U-M12G4-5R
			0.3 m + 2.5 m	–	8032309	NEDY-L2R1-V1-M8G3-U-0.3L-M12G4-2.5R
			0.3 m + 5 m	–	8035484	NEDY-L2R1-V1-M8G3-U-0.3L-M12G4-5R
		2x socket, M12 A-coded, 5-pin	2.5 m	–	8005305	NEDY-L2R1-V1-M12G5-U-M12G4-2.5R
			5 m	–	8005306	NEDY-L2R1-V1-M12G5-U-M12G4-5R
			0.3 m + 2.5 m	–	8035775	NEDY-L2R1-V1-M12G5-U-0.3L-M12G4-2.5R
		2x socket, plug pattern type A to EN 175301-803	0.3 m + 2.5 m	–	8035776	NEDY-L2R1-V1-M12G5-U-0.3L-M12G4-5R
			0.3 m + 2.5 m	–	8035791	NEDY-L2R1-V1-A1W4L-U-0.3L-M12G4-2.5R
		2x socket, plug pattern type B to industry standard, 11 mm	0.3 m + 2.5 m	–	8035779	NEDY-L2R1-V1-B2W3L-U-0.3L-M12G4-2.5R
			0.3 m + 2.5 m	–	8035783	NEDY-L2R1-V1-C1W4L-U-0.3L-M12G4-2.5R
		2x socket, plug pattern type C to EN 175301-803	0.3 m + 2.5 m	–	8035784	NEDY-L2R1-V1-C1W4L-U-0.3L-M12G4-5R
			0.3 m + 2.5 m	–	8035787	NEDY-L2R1-V1-Z4W2Z-U-0.3L-M12G4-2.5R
2x socket, plug pattern ZC, metric screw		0.3 m + 2.5 m	–	8035787	NEDY-L2R1-V1-Z4W2Z-U-0.3L-M12G4-2.5R	
Modular system for all types of sensor/actuator distributor				–	–	NEDY-... → Internet: nedy

Datasheet – Digital output modules

Ordering data – Accessories					
	Description		Pack size	Part no.	Type
Connecting cables					
	Modular system for a choice of connecting cables		–	8078221	NEBA-... → Internet: neba
Inscription labels					
	For modules CPX-AP-A	Size 6x 12.5 mm, 10 frames with 24 pieces each	240	8087174	ASLR-L-X4-612-P240
Covering					
	Cover cap for sealing unused connections	For connection M8x1	10	177672	ISK-M8
		For connection M12x1	10	165592	ISK-M12
	Cover for terminal strip (IP65, IP67)	<ul style="list-style-type: none"> • 8 cable through-feeds M9 • 1 cable through-feed for multi-pin plug 		538219	AK-8KL
	Fittings kit for covering hood			538220	VG-K-M9

Datasheet – Digital input/output modules

Function

Digital input/output modules allow electric sensors to be connected according to IEC 61131-2 type 3 (inductive, capacitive) and electrical consumers to IEC 61131-2 type 0.5 with an operating voltage of 24 V DC.

- Input/output modules for 24 V DC operating voltage
- Connection M8x1, 4-pin
- Connection M12x1, 5-pin
- Spring-loaded terminal connection
- Status and error indication via LED
- Electronic protection against short circuit or overload with automatic resetting
- Slow response; possible short-term increase in current requirement

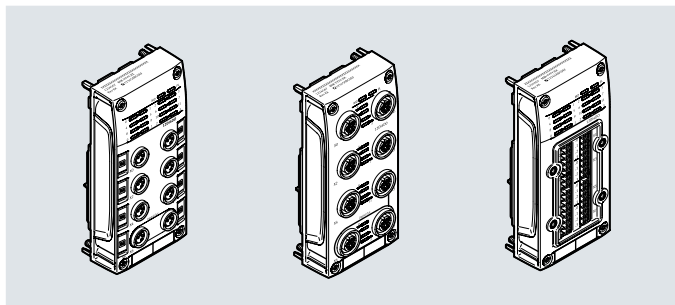

General technical data – Input/output modules

Communication interface, protocol	AP
Number of inputs	12
Number of outputs	4
Max. address volume for inputs	2 bytes
Max. address volume for outputs	1 bytes
Module parameters	Configuration of voltage monitoring of load supply PL; behaviour after short circuit/overload, analogue output
Channel parameter	Input debounce time
Diagnostics via LED	(Outputs) Diagnostics per channel; (outputs) power supply load; (inputs-outputs) diagnostics per module; (inputs-outputs) status per channel
Diagnostics via internal communication	Switch-off load supply; communication error; short circuit/overload output signal; sensor supply, short circuit/overload; overvoltage electronics/sensors; overvoltage load; undervoltage electronics/sensors; undervoltage load
Reverse polarity protection	Yes
Max. cable length	30 m outputs; 30 m inputs
Mounting position	Any

Datasheet – Digital input/output modules

Technical data – Interfaces – Input/output modules			
Electrical connection, connection type	8x socket M8x1, A-coded	8x socket M12x1, A-coded	8x terminal strip
Electrical connection for input, function	Digital input		
Electrical connection for input, connection type	6x socket		8x terminal strip
Electrical connection for input, connection technology	M8x1, A-coded to EN 61076-2-104	M12x1 A-coded to EN 61076-2-101	Spring-loaded terminal
Electrical connection for input, number of pins/cores	4	5	4
Electrical connection for input, conductor cross-section	–	–	0.25 ... 1.5 mm ²
Electrical connection for input, conductor cross-section AWG	–	–	AWG24 ... AWG16
Electrical connection for input, note on conductor cross-section	–	–	0.25 ... 1.5 mm ² for flexible conductor with wire ferrules and rigid conductors
			0.13 ... 1.5 mm ² for flexible conductors without wire ferrules
Electrical connection for output, function	Digital output		
Electrical connection for output, connection type	2 x socket		8x terminal strip
Electrical connection for output, connection technology	M8x1, A-coded to EN 61076-2-104	M12x1 A-coded to EN 61076-2-101	Spring-loaded terminal
Electrical connection for output, number of pins/cores	4	5	4
Electrical connection for output, conductor cross-section	–	–	0.25 ... 1.5 mm ²
Electrical connection for output, conductor cross-section AWG	–	–	AWG24 ... AWG16
Electrical connection for output, note on conductor cross-section	–	–	0.13 ... 1.5 mm ² for flexible conductors without wire ferrules
Switching logic at inputs	PNP (positive switching) 2-wire sensors to IEC 61131-2 3-wire sensors to IEC 61131-2		
Switching logic at outputs	PNP (positive switching)		
Characteristic curve of inputs	To IEC 61131-2, type 3		
Characteristic curve of outputs	To IEC 61131-2, type 0.5		
Switching level	Signal 0: ≤ 5 V Signal 1: ≥ 11 V		
Input debounce time	0.1 ms; 3 ms (standard); 10 ms; 20 ms		
Output delay with resistive load	Signal change 0->1: < 200 μs Signal change 1->0: < 200 μs		

Datasheet – Digital input/output modules

Technical data – Electrical – Input/output modules

Nominal operating voltage DC for electronics/sensors	24 V
Nominal operating voltage DC load	24 V
Permissible voltage fluctuations, electronics/sensors	± 25%
Permissible voltage fluctuations, load	± 25%
Note on the operating voltage	SELV/PELV power supply units required; note voltage drop
Note on nominal operating voltage DC	Protected extra-low voltage to IEC 60204-1
Power failure buffering	10 ms
Intrinsic current consumption at nominal operating voltage, electronics/sensors	Typical 40 mA
Intrinsic current consumption at nominal operating voltage, load	Typical 5 mA
Max. power supply per channel	0.5 A
Max. total current of inputs per module	1.8 A
Max. total current outputs per module	2 A
Electrical isolation between the supply voltages for electronics/sensors and load/valves	Yes
Electrical isolation of inputs between channels	No
Electrical isolation of inputs between channel - internal communication	Yes
Electrical isolation of outputs between channels	No
Electrical isolation of outputs between channel - internal communication	Yes
Protecting inputs (short circuit)	Internal electronic fuse per module
Behaviour after end of overload of the sensor supply	Automatic return
Protecting outputs (short circuit)	Internal electronic fuse per channel
Behaviour after end of overload of the outputs	No automatic return
Protection class	III
Overvoltage category	II
Pollution degree	2

Technical data – Mechanical – Input/output modules

Electrical connection, connection type	8x socket M8x1, A-coded	8x socket M12x1, A-coded	8x terminal strip
Type of mounting	Screw-clamped		
Product weight	88 g	98 g	97 g
Dimensions W x L x H	(incl. interlinking block); 50.1 mm × 107.3 mm × 57.5 mm		
Grid dimension	50.1 mm		

Materials – Input/output modules

Cover material	Reinforced PBT
O-ring material	FPM
Screw material	Nickel-plated steel
Note on materials	RoHS-compliant; free of halogen; free of phosphoric acid ester
LABS (PWIS) conformity	VDMA24364-B2-L

Datasheet – Digital input/output modules

Operating and environmental conditions – Input/output modules	
Ambient temperature	-20 ... 50 °C
Note on ambient temperature	Note ambient temperature derating to IEC 61131-2:2017
Storage temperature	-20 ... 70 °C
Corrosion resistance class CRC ¹⁾	1 - low corrosion stress
Relative humidity	5 ... 95%, non-condensing
Nominal operating altitude	<= 2000 m ASL (> 79.5 kPa)
Max. setup altitude	3500 m
Note on max. setup altitude	> 2000 m ASL (< 79.5 kPa) Note ambient temperature derating to IEC 61131-2:2017
Vibration resistant	Transport application test with severity level 2 to FN 942017-4 and EN 60068-2-6
Note on vibration resistance	SG1 on DIN rail SG2 on direct mounting Transport application test with severity level 1 to FN 942017-4 and EN 60068-2-6
Shock resistance	Shock test with severity level 2 to FN 942017-5 and EN 60068-2-27
Note on shock resistance	30 g/11 ms to EN 60068-2-27 SG1 on DIN rail SG2 on direct mounting Shock test with severity level 1 to FN 942017-5 and EN 60068-2-27
Material fire test	UL94 V-0 (housing)

1) More information www.festo.com/x/topic/crc

Datasheet – Digital input/output modules

Connection and indicator components – Module with 12 inputs, 4 outputs, 8x socket M8x1, A-coded

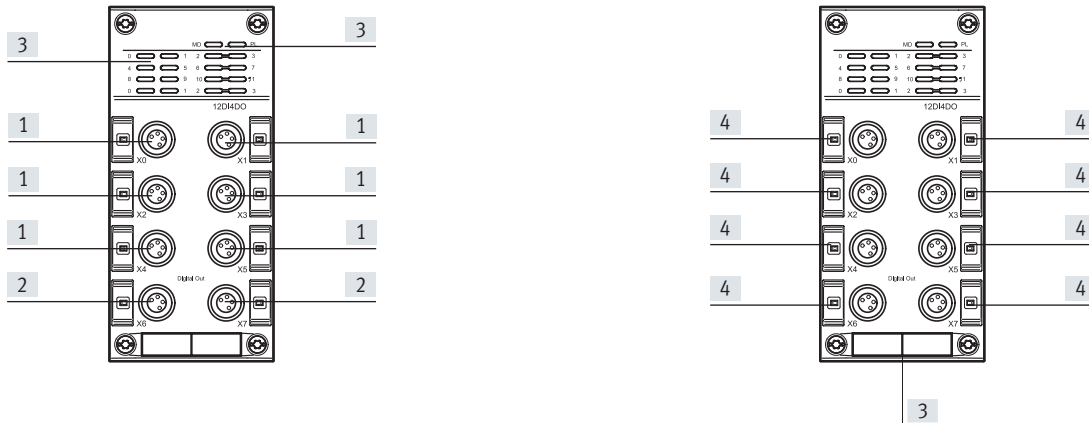

- [1] Electrical connection, inputs
- [2] Electrical connection, outputs
- [3] LED indicators
- [4] Space for inscription label

Connection and indicator components – Module with 12 inputs, 4 outputs, 8x socket M12x1 A-coded

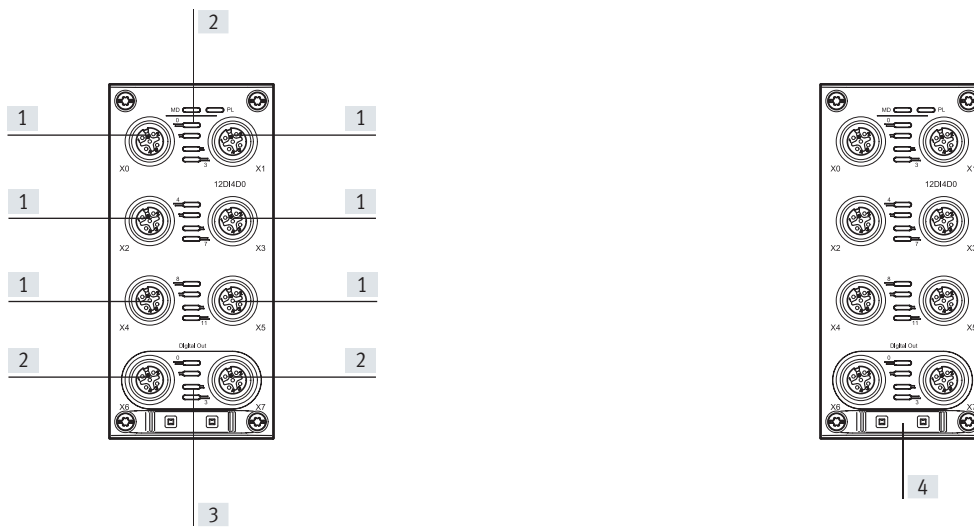

- [1] Electrical connection, inputs
- [2] Electrical connection, outputs
- [3] LED indicators
- [4] Space for inscription label

Datasheet – Digital input/output modules

Connection and indicator components – Module with 12 inputs, 4 outputs, 8x terminal strip

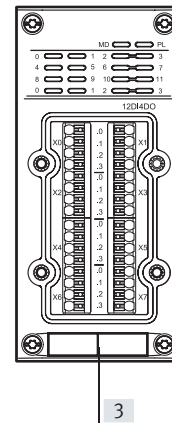
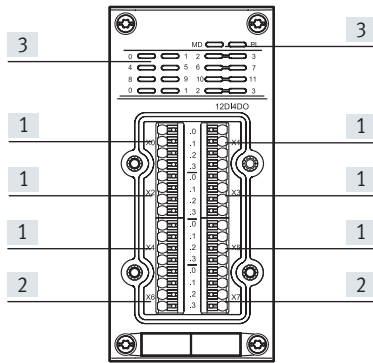

[1] Electrical connection, inputs

[2] Electrical connection, outputs

[4] Space for inscription label

[3] LED indicators

Datasheet – Digital input/output modules

Pin assignment – Inputs – Socket M8x1, A-coded

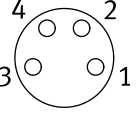
Terminal assignment	Pin	Assignment	Description
	1	24 V	Operating voltage 24 V
	2	Ix+1*	Input signal
	3	0 V	Operating voltage 0 V
	4	Ix*	Input signal

* Ix = Input x

Pin assignment – Outputs – Socket M8x1, A-coded

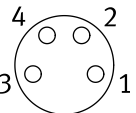
Terminal assignment	Pin	Assignment	Description
	1	n.c.	Not connected
	2	Ox+1*	Output signal
	3	0 V	Operating voltage 0 V
	4	Ox*	Output signal

* Ox = Output x

Pin assignment – Inputs – Socket M12x1, A-coded

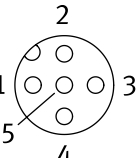
Terminal assignment	Pin	Assignment	Description
	1	24 V	Operating voltage 24 V
	2	Ix+1*	Input signal
	3	0 V	Operating voltage 0 V
	4	Ix*	Input signal
	5	FE	Functional earth

* Ix = Input x

Pin assignment – Outputs – Socket M12x1, A-coded

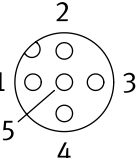
Terminal assignment	Pin	Assignment	Description
	1	n.c.	Not connected
	2	Ox+1*	Output signal
	3	0 V	Operating voltage 0 V
	4	Ox*	Output signal
	5	FE	Functional earth

* Ox = Output x

Datasheet – Digital input/output modules

Pin assignment – Inputs – Spring-loaded terminal			
Terminal assignment	Pin	Assignment	Description
	.0	24 V	Operating voltage 24 V
	.1	0 V	Operating voltage 0 V
	.2	Ix*	Input signal
	.3	Ix+1*	Input signal

* Ix = Input x

Pin assignment – Outputs – Spring-loaded terminal			
Terminal assignment	Pin	Assignment	Description
	.0	Ox*	Output signal
	.1	0 V	Operating voltage 0 V
	.2	Ox+1*	Output signal
	.3	FE	Functional earth

* Ox = Output x



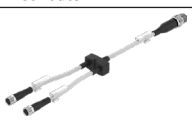

Datasheet – Digital input/output modules

Ordering data		Number of outputs	Number of inputs	Electrical connection		Part no.	Type
	Digital input/output module	4	12	8x socket M8x1, A-coded	4-pin	8129105	CPX-AP-A-12DI4DO-M8-4P
				8x socket M12x1, A-coded	5-pin	8129111	CPX-AP-A-12DI4DO-M12-5P
				8x terminal strip	4-pin	8129108	CPX-AP-A-12DI4DO-PI

Ordering data – Accessories						
Description				Pack size	Part no.	Type
Plug connectors for self-assembly						
	Plug M8x1, 4-pin, straight	Insulation displacement connector	Connection cross-section 0.14 ... 0.34 mm ²	–	562025	NECU-S-M8G4-HX
		Screw terminal	Connection cross-section 0.14 ... 0.75 mm ²	–	8162299	NECB-S-M8G4-C2
	Straight plug, M12x1, 5-pin, A-coded	Screw terminal	Cable	–	8162296	NECB-S-M12G5-C2
			2x cable	–	8162297	NECB-S-M12G5-C2-D
	Straight plug, M12x1, 4-pin, A-coded	Insulation displacement connector	–	–	562028	NECU-S-M12G4-HX

Distributor						
	Straight plug, M12x1, 4-pin, A-coded	2x socket, M8 A-coded, 3-pin	2.5 m	–	8005301	NEDY-L2R1-V1-M8G3-U-M12G4-2.5R
			5 m	–	8005302	NEDY-L2R1-V1-M8G3-U-M12G4-5R
			0.3 m + 2.5 m	–	8032309	NEDY-L2R1-V1-M8G3-U-0.3L-M12G4-2.5R
			0.3 m + 5 m	–	8035484	NEDY-L2R1-V1-M8G3-U-0.3L-M12G4-5R
		2x socket, M12 A-coded, 5-pin	2.5 m	–	8005305	NEDY-L2R1-V1-M12G5-U-M12G4-2.5R
			5 m	–	8005306	NEDY-L2R1-V1-M12G5-U-M12G4-5R
			0.3 m + 2.5 m	–	8035775	NEDY-L2R1-V1-M12G5-U-0.3L-M12G4-2.5R
			0.3 m + 5 m	–	8035776	NEDY-L2R1-V1-M12G5-U-0.3L-M12G4-5R
		2x socket, plug pattern type A to EN 175301-803	0.3 m + 2.5 m	–	8035791	NEDY-L2R1-V1-A1W4L-U-0.3L-M12G4-2.5R
		2x socket, plug pattern type B to industry standard, 11 mm	0.3 m + 2.5 m	–	8035779	NEDY-L2R1-V1-B2W3L-U-0.3L-M12G4-2.5R
		2x socket, plug pattern type C to EN 175301-803	0.3 m + 2.5 m	–	8035783	NEDY-L2R1-V1-C1W4L-U-0.3L-M12G4-2.5R
			0.3 m + 5 m	–	8035784	NEDY-L2R1-V1-C1W4L-U-0.3L-M12G4-5R
		2x socket, plug pattern ZC, metric screw	0.3 m + 2.5 m	–	8035787	NEDY-L2R1-V1-Z4W2Z-U-0.3L-M12G4-2.5R
Modular system for all types of sensor/actuator distributor				–	–	NEDY-... → Internet: nedy

Datasheet – Digital input/output modules

Ordering data – Accessories					
	Description		Pack size	Part no.	Type
Connecting cables					
	Modular system for a choice of connecting cables		–	8078221	NEBA-... → Internet: neba
Inscription labels					
	For modules CPX-AP-A	Size 6x 12.5 mm, 10 frames with 24 pieces each	240	8087174	ASLR-L-X4-612-P240
Covering					
	Cover cap for sealing unused connections	For connection M8x1	10	177672	ISK-M8
		For connection M12x1	10	165592	ISK-M12
	Cover for terminal strip (IP65, IP67)	<ul style="list-style-type: none"> • 8 cable through-feeds M9 • 1 cable through-feed for multi-pin plug 		538219	AK-8KL
	Fittings kit for covering hood			538220	VG-K-M9

Datasheet – Digital input/output modules PROFI-safe

Function

Digital input/output modules with functional safety allow up to 6 safe, single-channel sensors and three safe, dual-channel outputs to be connected. Communication with the higher-order controller takes place via the PROFI-safe protocol within a PROFINET fieldbus.

- Input/output modules for 24 V DC operating voltage
- Connection M12x1, 5-pin
- Status and error indication via LED
- Electronic protection against short circuit or overload
- Slow response; possible short-term increase in current requirement

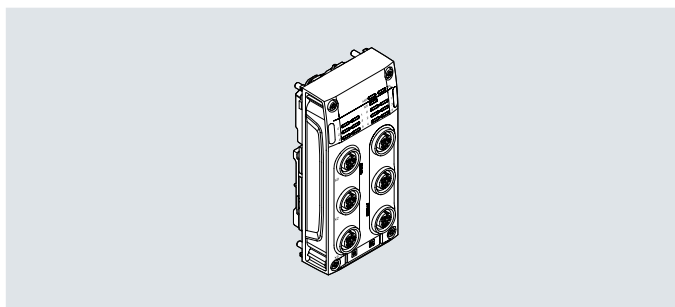

General technical data – Input/output modules PROFI-safe

Communication interface, protocol	AP
Number of inputs	6
Number of outputs	3
Max. address volume for inputs	5 bytes
Max. address volume for outputs	6 bytes
Module parameters	FDevice destination address; FDevice source address; configuration of voltage monitoring load supply PL
Channel parameter	–
Diagnostics via LED	(Outputs) Diagnostics per channel; (outputs) power supply load; (inputs-outputs) diagnostics per module; (inputs-outputs) status per channel
Diagnostics via internal communication	–
Reverse polarity protection	Yes
Max. cable length	200 m outputs; 200 m inputs
Mounting position	Any

Technical data – Interfaces – Input/output modules PROFI-safe

Electrical connection for input, function	Digital input
Electrical connection for input, connection type	3x socket
Electrical connection for input, connection technology	M12x1, A-coded to EN 61076-2-101
Electrical connection for input, number of pins/cores	5
Electrical connection for output, function	Digital output
Electrical connection for output, connection type	3 x socket
Electrical connection for output, connection technology	M12x1, A-coded to EN 61076-2-101
Electrical connection for output, number of pins/cores	5
Switching logic at inputs	PNP (positive switching) 2-wire sensors to IEC 61131-2 3-wire sensors to IEC 61131-2
Switching logic at outputs	PNP (positive switching)
Characteristic curve of inputs	To IEC 61131-2, type 3
Characteristic curve of outputs	Based on IEC1131-T2, according to IEC 61131-2, type 2
Switching level	Signal 0: ≤ 5 V Signal 1: ≥ 11 V
Input debounce time	2.5 ms
Output delay with resistive load	Signal change 0->1: < 100 μ s Signal change 1->0: < 100 μ s

Datasheet – Digital input/output modules PROFIsafe

Technical data – Electrical – Input/output modules PROFIsafe	
Nominal operating voltage DC for electronics/sensors	24 V
Nominal operating voltage DC load	24 V
Permissible voltage fluctuations, electronics/sensors	± 25%
Permissible voltage fluctuations, load	± 25%
Note on the operating voltage	SELV/PELV power supply units required; note voltage drop
Note on nominal operating voltage DC	Protected extra-low voltage to IEC 60204-1
Power failure buffering	10 ms
Intrinsic current consumption at nominal operating voltage, electronics/sensors	Typical 60 mA
Intrinsic current consumption at nominal operating voltage, load	Typical 15 mA
Max. power supply per channel	1.5 A
Max. total current of inputs per module	1.44 A
Max. total current outputs per module	4.5 A
Electrical isolation between the supply voltages for electronics/sensors and load/valves	Yes
Electrical isolation of inputs between channels	No
Electrical isolation of inputs between channel - internal communication	No
Electrical isolation of outputs between channels	No
Electrical isolation of outputs between channel - internal communication	Yes
Protecting inputs (short circuit)	Internal electronic fuse per channel
Behaviour after end of overload of the sensor supply	Automatic return
Protecting outputs (short circuit)	Internal electronic fuse per channel
Behaviour after end of overload of the outputs	No automatic return
Protection class	III
Overvoltage category	II
Pollution degree	2

Datasheet – Digital input/output modules PROFIsafe

Technical data – Mechanical – Input/output modules PROFIsafe

Type of mounting	Screw-clamped
Product weight	145 g
Dimensions W x L x H	(incl. interlinking block); 50.1 mm × 107.3 mm × 57.5 mm
Grid dimension	50.1 mm

Materials – Input/output modules PROFIsafe

Cover material	Reinforced PBT
O-ring material	FPM
Threaded sleeve material	High-alloy stainless steel
Screw material	Nickel-plated steel
Note on materials	RoHS-compliant; free of halogen; free of phosphoric acid ester
LABS (PWIS) conformity	VDMA24364-B2-L

Operating and environmental conditions – Input/output modules PROFIsafe

Ambient temperature	-20 ... 50 °C
Storage temperature	-20 ... 70 °C
Corrosion resistance class CRC ¹⁾	1 - low corrosion stress
Relative humidity	5 - 95%, non-condensing
Nominal operating altitude	<= 2000 m ASL (> 79.5 kPa)
Note on ambient temperature	Note the derating in the user documentation; note the ambient temperature derating to IEC 61131-2:2017.
Max. setup altitude	3,500 m
Note on max. setup altitude	> 2000 m ASL (< 79.5 kPa) Note derating according to user documentation Note ambient temperature derating to IEC 61131-2:2017
Vibration resistant	Transport application test with severity level 2 to FN 942017-4 and EN 60068-2-6
Note on vibration resistance	SG1 on DIN rail SG2 on direct mounting Transport application test with severity level 1 to FN 942017-4 and EN 60068-2-6
Shock resistance	Shock test with severity level 2 to FN 942017-5 and EN 60068-2-27
Note on shock resistance	30 g/11 ms to EN 60068-2-27 SG1 on DIN rail SG2 on direct mounting Shock test with severity level 1 to FN 942017-5 and EN 60068-2-27
Material fire test	UL94 V-0 (housing)

1) More information www.festo.com/x/topic/crc

Datasheet – Digital input/output modules PROFIsafe

Connection and indicator components – Module with 6 inputs, 3 outputs, 6x socket M12x1 A-coded

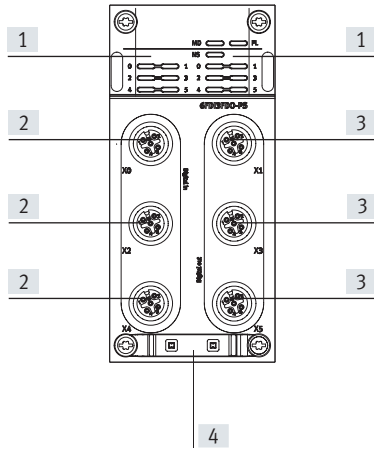

- [1] LED indicators
- [2] Electrical connection, inputs
- [3] Electrical connection, outputs
- [4] Space for inscription label

Pin assignment – Inputs – Socket M12x1, A-coded

Terminal assignment	Pin	Assignment	Description
	1	24 V	Operating voltage 24 V
	2	Ix+1*	Input signal
	3	0 V	Operating voltage 0 V
	4	Ix*	Input signal
	5	FE	Functional earth







* Ix = Input x

Pin assignment – Outputs – Socket M12x1, A-coded

Terminal assignment	Pin	Assignment	Description
	1	n.c.	Not connected
	2	Ox+1*	Output signal
	3	0 V	Operating voltage 0 V
	4	Ox*	Output signal
	5	FE	Functional earth

* Ox = Output x

Datasheet – Digital input/output modules PROFIsafe

Ordering data								
		Number of outputs	Number of inputs	Electrical connection		Part no.	Type	
	Digital input/output module	3	6	6x socket M12x1, A-coded	5-pin	8129117	CPX-AP-A-6FDI3FDO-PS-M12-5P	
Ordering data – Accessories								
	Description			Pack size		Part no.	Type	
Plug connectors for self-assembly								
	Straight plug, M12x1, 5-pin, A-coded	Screw terminal	Cable	–		8162296	NECB-S-M12G5-C2	
			2x cable	–		8162297	NECB-S-M12G5-C2-D	
	Straight plug, M12x1, 4-pin, A-coded	Insulation displacement connector	–	–		562028	NECU-S-M12G4-HX	
Distributor								
	Straight plug, M12x1, 4-pin, A-coded	2x socket, M8 A-coded, 3-pin	2.5 m	–		8005301	NEDY-L2R1-V1-M8G3-U-M12G4-2.5R	
			5 m	–		8005302	NEDY-L2R1-V1-M8G3-U-M12G4-5R	
			0.3 m + 2.5 m	–		8032309	NEDY-L2R1-V1-M8G3-U-0.3L-M12G4-2.5R	
			0.3 m + 5 m	–		8035484	NEDY-L2R1-V1-M8G3-U-0.3L-M12G4-5R	
			2x socket, M12 A-coded, 5-pin	2.5 m	–		8005305	NEDY-L2R1-V1-M12G5-U-M12G4-2.5R
				5 m	–		8005306	NEDY-L2R1-V1-M12G5-U-M12G4-5R
				0.3 m + 2.5 m	–		8035775	NEDY-L2R1-V1-M12G5-U-0.3L-M12G4-2.5R
				0.3 m + 5 m	–		8035776	NEDY-L2R1-V1-M12G5-U-0.3L-M12G4-5R
			2x socket, plug pattern type A to EN 175301-803	0.3 m + 2.5 m	–		8035791	NEDY-L2R1-V1-A1W4L-U-0.3L-M12G4-2.5R
			2x socket, plug pattern type B to industry standard, 11 mm	0.3 m + 2.5 m	–		8035779	NEDY-L2R1-V1-B2W3L-U-0.3L-M12G4-2.5R
			2x socket, plug pattern type C to EN 175301-803	0.3 m + 2.5 m	–		8035783	NEDY-L2R1-V1-C1W4L-U-0.3L-M12G4-2.5R
				0.3 m + 5 m	–		8035784	NEDY-L2R1-V1-C1W4L-U-0.3L-M12G4-5R
			2x socket, plug pattern ZC, metric screw	0.3 m + 2.5 m	–		8035787	NEDY-L2R1-V1-Z4W2Z-U-0.3L-M12G4-2.5R
	Modular system for all types of sensor/actuator distributor			–		–	NEDY-... → Internet: nedy	
Connecting cables								
	Modular system for a choice of connecting cables			–		8078221	NEBA-... → Internet: neba	
Inscription labels								
	For modules CPX-AP-A	Size 6x 12.5 mm, 10 frames with 24 pieces each	240			8087174	ASLR-L-X4-612-P240	
Covering								
	Cover cap for sealing unused connections		For connection M12x1	10		165592	ISK-M12	

Datasheet – End plates

Function

The end plates form the lateral end of the remote I/O system CPX-AP-A and provide mounting holes for mounting on a wall, DIN rail or support system.

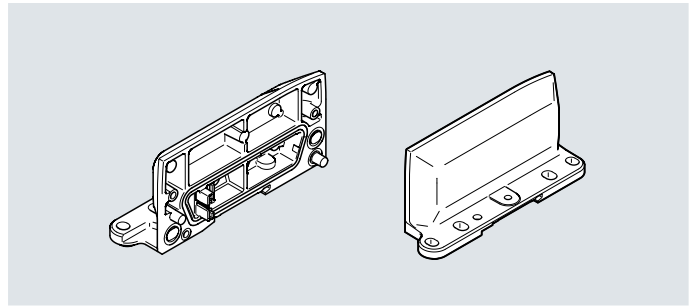

General technical data – End plates

Mounting position	Any, on DIN rail: horizontal
-------------------	------------------------------

Technical data – Electrical – End plates

Protection class	III
Overvoltage category	II

Technical data – Mechanical – End plates

	Left end plate	Right end plate
Type of mounting	Direct mounting via through-hole; on DIN rail with accessories; on mounting frame; with through-hole for screw M5; with through-hole for screw M6	
Product weight	120 g	116 g
Dimensions W x L x H	(Installation dimensions); 30.4 mm x 117.2 mm x 53.6 mm	

Materials – End plates

	Left end plate	Right end plate
End plate material	Coated die-cast aluminium	Coated die-cast aluminium
Sealing material	–	Polyurethane foam
Screw material	Nickel-plated steel; galvanised steel	Nickel-plated steel
Note on materials	RoHS-compliant; free of halogen; free of phosphoric acid ester	RoHS-compliant; free of halogen; free of phosphoric acid ester
LABS (PWIS) conformity	VDMA24364-B2-L	VDMA24364-B2-L



Operating and environmental conditions – End plates

Ambient temperature	-20 ... 50 °C
Note on ambient temperature	Note ambient temperature derating to IEC 61131-2:2017
Storage temperature	-20 ... 70 °C
Corrosion resistance class CRC ¹⁾	1 - low corrosion stress
Relative humidity	5 - 95%, non-condensing
Nominal operating altitude	<= 2000 m ASL (> 79.5 kPa)
Max. setup altitude	3500 m
Note on max. setup altitude	> 2000 m ASL (< 79.5 kPa) Note ambient temperature derating to IEC 61131-2:2017
Vibration resistant	Transport application test with severity level 2 to FN 942017-4 and EN 60068-2-6
Note on vibration resistance	SG1 on DIN rail SG2 on direct mounting Transport application test with severity level 1 to FN 942017-4 and EN 60068-2-6
Shock resistance	Shock test with severity level 2 to FN 942017-5 and EN 60068-2-27
Note on shock resistance	30 g/11 ms to EN 60068-2-27 SG1 on DIN rail SG2 on direct mounting Shock test with severity level 1 to FN 942017-5 and EN 60068-2-27

1) More information www.festo.com/x/topic/crc

Datasheet – End plates

Ordering data		Part no.	Type
	Left end plate	8112476	CPX-AP-A-EPL
	Right end plate	8112477	CPX-AP-A-EPR

Ordering data – Accessories				
	Description	Pack size	Part no.	Type
Mounting				
	For DIN rail mounting	–	8159824	CAFM-X5-H
	For mounting on support system with valve terminal VTSA/VTSA-F/VTSA-F-CB	–	8130845	CAFM-X5-K

Datasheet – Interlinking block with system supply

Function

Interlinking blocks ensure the electrical supply of all other CPX-AP-A modules. They have contact rails, from which the other CPX components on the interlinking modules are supplied with power.

The internal division of the power supply allows specific areas of the sensors and actuators to be switched off individually.

Application area

- 24 V DC supply voltage for the electronics of the remote I/O system CPX-AP-A
- 24 V DC supply voltage for inputs
- 24 V DC supply voltage for valves
- 24 V DC supply voltage for outputs

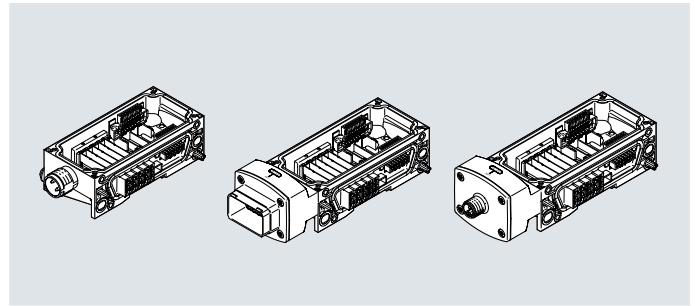

General technical data – System supply for interlinking blocks

Mounting position	Any, on DIN rail: horizontal
-------------------	------------------------------

Technical data – Interfaces – System supply for interlinking blocks

Power supply, connection technology	7/8" to NFPA/T3.5.29	M12x1, L-coded to EN 61076-2-111	M18x1	Push-pull to IEC 61076-3-126
Power supply, function	Incoming electronics/sensors and load and functional earth			
Power supply, connection type	Plug			
Power supply, number of pins/cores	5		4	5
Power supply, conductor cross-section	1.5 mm ²	2.5 mm ²		

Technical data – Electrical – System supply for interlinking blocks

Power supply, connection technology	7/8" to NFPA/T3.5.29	M12x1, L-coded to EN 61076-2-111	M18x1	Push-pull to IEC 61076-3-126
Nominal operating voltage DC for electronics/sensors	24 V			
Nominal operating voltage DC load	24 V			
Note on the operating voltage	SELV/PELV power supply units required; note voltage drop			
Note on nominal operating voltage DC	2x24 V [XD1,PS,PL], protected extra-low voltage to IEC 60204-1			
Nominal current	8 A	10 A, 16 A	8 A	10 A
Max. power supply	2 x 8 A (external fuse required)	2 x 10 A (external fuse required)	2 x 8 A (external fuse required)	2 x 10 A (external fuse required)
Electrical isolation between the supply voltages for electronics/sensors and load/valves	Yes		No	Yes
Protection class	III			
Overvoltage category	II			

Datasheet – Interlinking block with system supply

Technical data – Mechanical – System supply for interlinking blocks

Power supply, connection technology	7/8" to NFPA/T3.5.29	M12x1, L-coded to EN 61076-2-111	M18x1	Push-pull to IEC 61076-3-126
Type of mounting	On DIN rail with accessories; with through-hole for M5 screw with accessories; with through-hole for screw M6 with accessories			
Product weight	113 g	178 g	111 g	182 g
Dimensions W x L x H	(Installation dimensions); 50.1 mm x 122 mm x 35 mm	(Installation dimensions); 50.1 mm x 150 mm x 45.6 mm	(Installation dimensions); 50.1 mm x 124 mm x 35 mm	(Installation dimensions); 50.1 mm x 153 mm x 45.6 mm
Grid dimension	50.1 mm			

Materials – Interlinking blocks with system supply

Power supply, connection technology	7/8" to NFPA/T3.5.29	M12x1, L-coded to EN 61076-2-111	M18x1	Push-pull to IEC 61076-3-126
Housing material	Reinforced PA			
Sealing material	Polyurethane foam			
Threaded seal material	TPE-U(PU)	–		
Flange material	–	Nickel-plated die-cast zinc	–	Nickel-plated die-cast zinc
Screw material	Nickel-plated steel			
Note on materials	RoHS-compliant; free of halogen; free of phosphoric acid ester			
LABS (PWIS) conformity	VDMA24364-B2-L			

Operating and environmental conditions – System supply for interlinking blocks

Ambient temperature	-20 ... 50 °C
Note on ambient temperature	Note ambient temperature derating to IEC 61131-2:2017
Storage temperature	-20 ... 70 °C
Corrosion resistance class CRC ¹⁾	1 - low corrosion stress
Relative humidity	5 - 95%, non-condensing
Nominal operating altitude	<= 2000 m ASL (> 79.5 kPa)
Max. setup altitude	3500 m
Note on max. setup altitude	> 2000 m ASL (< 79.5 kPa) Note ambient temperature derating to IEC 61131-2:2017
Vibration resistant	Transport application test with severity level 2 to FN 942017-4 and EN 60068-2-6
Note on vibration resistance	SG1 on DIN rail SG2 on direct mounting Transport application test with severity level 1 to FN 942017-4 and EN 60068-2-6
Shock resistance	Shock test with severity level 2 to FN 942017-5 and EN 60068-2-27
Note on shock resistance	30 g/11 ms to EN 60068-2-27 SG1 on DIN rail SG2 on direct mounting Shock test with severity level 1 to FN 942017-5 and EN 60068-2-27
Material fire test	UL94 V-0 (housing)

1) More information www.festo.com/x/topic/crc

Datasheet – Interlinking block with system supply

Pin assignment, system supply M18x1, 4-pin

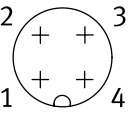
Terminal assignment	Pin	Assignment	Description
	1	24 V	Operating voltage 24 V electronics and sensors
	2	24 V	Operating voltage 24 V load voltage supply
	3	0 V	Operating voltage 0 V load voltage supply, electronics and sensors
	4	FE	Functional earth

Pin assignment, system supply M12x1, L-coded, 5-pin

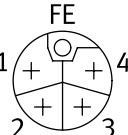
Terminal assignment	Pin	Assignment	Description
	1	24 V	Operating voltage 24 V electronics and sensors
	2	0 V	Operating voltage 0 V load voltage supply
	3	0 V	Operating voltage 0 V electronics and sensors
	4	24 V	Operating voltage 24 V load voltage supply
	FE	FE	Functional earth



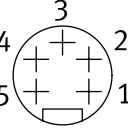

Pin assignment, system supply 7/8" to NFPA/T3.5.29, 5-pin

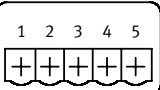







Terminal assignment	Pin	Assignment	Description
	1	0 V	Operating voltage 0 V load voltage supply
	2	0 V	Operating voltage 0 V electronics and sensors
	3	FE	Functional earth
	4	24 V	Operating voltage 24 V electronics and sensors
	5	24 V	Operating voltage 24 V load voltage supply

Pin assignment, system supply push-pull to IEC 61076-3-126, 5-pin

Terminal assignment	Pin	Assignment	Description
	1	24 V	Operating voltage 24 V electronics and sensors
	2	0 V	Operating voltage 0 V electronics and sensors
	3	24 V	Operating voltage 24 V load voltage supply
	4	0 V	Operating voltage 0 V load voltage supply
	5	FE	Functional earth

Datasheet – Interlinking block with system supply

Ordering data						
	Power supply Function	Connection type	Connection technology	Number of pins/cores	Part no.	Type
	Incoming electronics/ sensors and load and functional earth	Plug	M12x1, L-coded to EN 61076-2-111	5	8129256	CPX-AP-A-S-1-M12-5P
			M18x1	4	8129254	CPX-AP-A-S-1-M18-4P
			7/8" to NFPA/T3.5.29	5	8129255	CPX-AP-A-S-1-7/8-5P
			Push-pull to IEC 61076-3-126	5	8129253	CPX-AP-A-S-1-PP-5P

Ordering data – Accessories					
	Description	Cable fitting	Permissible cable diameter	Part no.	Type
Plug connectors for self-assembly					
	Straight socket, M12x1, L-coded to EN 61076-2-111, 5-pin	–	8 - 13 mm for electrical connection 1	8166793	NECL-L12G5-C2-Q10
	Angled socket, M12x1, L-coded to EN 61076-2-111, 5-pin	–	8 - 13 mm for electrical connection 1	8166794	NECL-L12W5-C2-Q10
	Straight socket, 4-pin	Pg9	6 - 8 mm	18493	NTSD-GD-9
		Pg13	10 - 12 mm	18526	NTSD-GD-13.5
	Angled socket, 4-pin	Pg9	6 - 8 mm	18527	NTSD-WD-9
		Pg11	5 - 11 mm	533119	NTSD-WD-11
	Straight socket, 7/8", 5-pin	–	6 - 12 mm	543107	NECU-G78G5-C2
	Straight socket, plug pattern PP, coding on pin 2 and 5	Pg13.5, hex, AF22	9 - 13 mm	5195383	NECU-M-PPG5PP-C1-PN
Cable seal					
	For push-pull to IEC 61076-3-126	For adapting to cable diameter 6.5 ... 9.5 mm		8079860	NEAU-KD-P4-A1-P5
Mounting					
	For wall mounting			8130844	CAF-M-X5-A

Datasheet – Interlinking block with system supply and forwarding supply

Function

Interlinking blocks ensure the electrical supply of all other CPX-AP-A modules. They have contact rails, from which the other CPX components on the interlinking modules are supplied with power.

The internal division of the power supply allows specific areas of the sensors and actuators to be switched off individually.

Application area

- 24 V DC supply voltage for the electronics of the remote I/O system CPX-AP-A
- 24 V DC supply voltage for inputs
- 24 V DC supply voltage for valves
- 24 V DC supply voltage for outputs

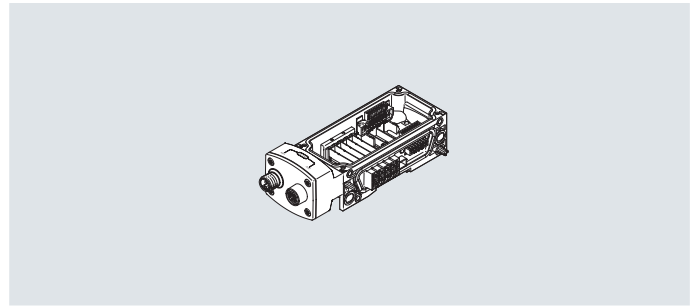

General technical data – Interlinking blocks with system supply and forwarding supply

Mounting position	Any, on DIN rail: horizontal
-------------------	------------------------------

Technical data – Interface – Interlinking blocks with system supply and forwarding supply

Power supply, number of pins/cores	4	5
Power supply, function	Incoming electronics/sensors and load	Incoming electronics/sensors and load and functional earth
Power supply, connection type	Plug	
Power supply, connection technology	M12x1, L-coded to EN 61076-2-111	
Power supply, conductor cross-section	2.5 mm ²	
Power transmission, function	Outgoing electronics/sensors and load	Outgoing electronics/sensors and load and functional earth
Power transmission, connection type	Socket	
Power transmission, connection technology	M12x1, L-coded to EN 61076-2-111	
Power transmission, number of pins/cores	4	5

Technical data – Electrical – Interlinking blocks with system supply and forwarding supply

Nominal operating voltage DC for electronics/sensors	24 V
Nominal operating voltage DC load	24 V
Note on the operating voltage	SELV/PELV power supply units required; note voltage drop
Note on nominal operating voltage DC	2x24 V [XD1,PS,PL], protected extra-low voltage to IEC 60204-1
Nominal current	16 A
Max. power supply	2 x 16 A (external fuse required)
Electrical isolation between the supply voltages for electronics/sensors and load/valves	Yes
Protection class	III
Overvoltage category	II

Datasheet – Interlinking block with system supply and forwarding supply

Technical data – Mechanical – Interlinking blocks with system supply and forwarding supply

Power supply, number of pins/cores	4	5
Type of mounting	On DIN rail with accessories; with through-hole for M5 screw with accessories; with through-hole for screw M6 with accessories	
Product weight	177 g	183 g
Dimensions W x L x H	50.1 mm x 150 mm x 45.6 mm	(Installation dimensions); 50.1 mm x 150 mm x 45.6 mm
Grid dimension	50.1 mm	

Materials – Interlinking blocks with system supply and forwarding supply

Housing material	Reinforced PA
O-ring material	FPM
Sealing material	Polyurethane foam
Flange material	Nickel-plated die-cast zinc
Screw material	Nickel-plated steel
Note on materials	RoHS-compliant; free of halogen; free of phosphoric acid ester
LABS (PWIS) conformity	VDMA24364-B2-L

Operating and environmental conditions – Interlinking blocks with system supply and forwarding supply

Ambient temperature	-20 ... 50 °C
Note on ambient temperature	Note ambient temperature derating to IEC 61131-2:2017
Storage temperature	-20 ... 70 °C
Corrosion resistance class CRC ¹⁾	1 - low corrosion stress
Relative humidity	5 - 95%, non-condensing
Nominal operating altitude	<= 2000 m ASL (> 79.5 kPa)
Max. setup altitude	3,500 m
Note on max. setup altitude	> 2000 m ASL (< 79.5 kPa) Note ambient temperature derating to IEC 61131-2:2017
Vibration resistant	Transport application test with severity level 2 to FN 942017-4 and EN 60068-2-6
Note on vibration resistance	SG1 on DIN rail SG2 on direct mounting Transport application test with severity level 1 to FN 942017-4 and EN 60068-2-6
Shock resistance	Shock test with severity level 2 to FN 942017-5 and EN 60068-2-27
Note on shock resistance	30 g/11 ms to EN 60068-2-27 SG1 on DIN rail SG2 on direct mounting Shock test with severity level 1 to FN 942017-5 and EN 60068-2-27
Material fire test	UL94 V-0 (housing)

1) More information www.festo.com/x/topic/crc

Datasheet – Interlinking block with system supply and forwarding supply

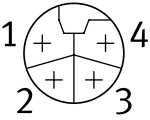
Pin assignment, system supply M12x1, L-coded, 4-pin			
Terminal assignment	Pin	Assignment	Description
	1	24 V	Operating voltage 24 V electronics and sensors
	2	0 V	Operating voltage 0 V load voltage supply
	3	0 V	Operating voltage 0 V electronics and sensors
	4	24 V	Operating voltage 24 V load voltage supply

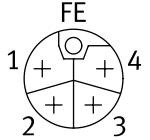

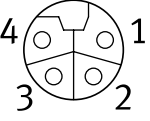

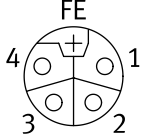





Pin assignment, system supply M12x1, L-coded, 5-pin			
Terminal assignment	Pin	Assignment	Description
	1	24 V	Operating voltage 24 V electronics and sensors
	2	0 V	Operating voltage 0 V load voltage supply
	3	0 V	Operating voltage 0 V electronics and sensors
	4	24 V	Operating voltage 24 V load voltage supply
	FE	FE	Functional earth

Pin assignment, forwarding supply M12x1, L-coded, 4-pin			
Terminal assignment	Pin	Assignment	Description
	1	24 V	Operating voltage 24 V electronics and sensors
	2	0 V	Operating voltage 0 V load voltage supply
	3	0 V	Operating voltage 0 V electronics and sensors
	4	24 V	Operating voltage 24 V load voltage supply

Pin assignment, forwarding supply M12x1, L-coded, 5-pin			
Terminal assignment	Pin	Assignment	Description
	1	24 V	Operating voltage 24 V electronics and sensors
	2	0 V	Operating voltage 0 V load voltage supply
	3	0 V	Operating voltage 0 V electronics and sensors
	4	24 V	Operating voltage 24 V load voltage supply
	FE	FE	Functional earth

Datasheet – Interlinking block with system supply and forwarding supply

Ordering data	Power supply		Power transmission		Part no.	Type
	Connection technology	Number of pins/cores	Connection technology	Number of pins/cores		
	M12x1, L-coded to EN 61076-2-111	4	M12x1, L-coded to EN 61076-2-111	4	8195677	CPX-AP-A-S-2-M12-4P
		5		5		

Ordering data – Accessories					
	Description	Cable fitting	Permissible cable diameter	Part no.	Type
Plug connectors for self-assembly					
	Straight socket, M12x1, L-coded to EN 61076-2-111, 4-pin	–	8 - 13 mm for electrical connection 1	8203701	NECL-L12G4-C2-Q10
	Straight socket, M12x1, L-coded to EN 61076-2-111, 5-pin	–	8 - 13 mm for electrical connection 1	8166793	NECL-L12G5-C2-Q10
	Angled socket, M12x1, L-coded to EN 61076-2-111, 4-pin	–	8 - 13 mm for electrical connection 1	8203702	NECL-L12W4-C2-Q10
	Angled socket, M12x1, L-coded to EN 61076-2-111, 5-pin	–	8 - 13 mm for electrical connection 1	8166794	NECL-L12W5-C2-Q10
	Straight plug, M12x1, L-coded to EN 61076-2-111, 4-pin	–	8 - 13 mm for electrical connection 1	8203699	NECL-S-L12G4-C2-Q10
	Straight plug, M12x1, L-coded to EN 61076-2-111, 5-pin	–	8 - 13 mm for electrical connection 1	8166791	NECL-S-L12G5-C2-Q10
	Angled plug, M12x1, L-coded to EN 61076-2-111, 4-pin	–	8 - 13 mm for electrical connection 1	8203700	NECL-S-L12W4-C2-Q10
	Angled plug, M12x1, L-coded to EN 61076-2-111, 5-pin	–	8 - 13 mm for electrical connection 1	8166792	NECL-S-L12W5-C2-Q10
	Straight socket, 4-pin	Pg9	6 - 8 mm	18493	NTSD-GD-9
		Pg13	10 - 12 mm	18526	NTSD-GD-13.5
	Angled socket, 4-pin	Pg9	6 - 8 mm	18527	NTSD-WD-9
		Pg11	5 - 11 mm	533119	NTSD-WD-11
	Straight socket, 7/8", 5-pin	–	6 - 12 mm	543107	NECU-G78G5-C2
	Straight socket, plug pattern PP, coding on pin 2 and 5	Pg13.5, hex, AF22	9 - 13 mm	5195383	NECU-M-PPG5PP-C1-PN
Cable seal					
	For push-pull to IEC 61076-3-126	For adapting to cable diameter 6.5 ... 9.5 mm		8079860	NEAU-KD-P4-A1-P5
Mounting					
	For wall mounting			8130844	CAFM-X5-A

Datasheet – Interlinking block with additional supply

Function

Interlinking blocks ensure the electrical supply of all other CPX-AP-A modules. They have contact rails, from which the other CPX components on the interlinking modules are supplied with power.

The internal division of the power supply allows specific areas of the sensors and actuators to be switched off individually.

Application area

- All voltages are fed through to the next module via the interlinking blocks with additional supply.
- The interlinking blocks with additional supply make all voltages available to an external consumer.
- 24 V DC supply voltage for valves
- 24 V DC supply voltage for outputs

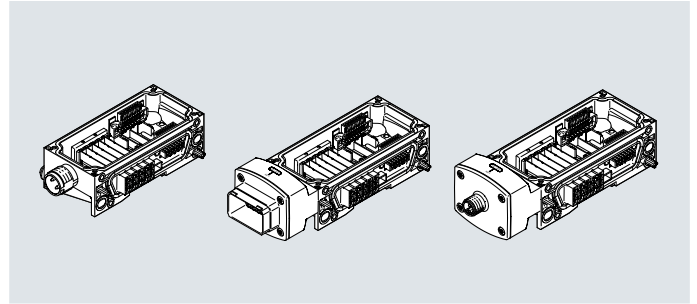

General technical data – Additional supply for interlinking blocks

Mounting position	Any, on DIN rail: horizontal
-------------------	------------------------------

Technical data – Interfaces – Additional supply for interlinking blocks

Power supply, connection technology	7/8" to NFPA/T3.5.29	M12x1, L-coded to EN 61076-2-111	M18x1	Push-pull to IEC 61076-3-126
Power supply, function	Incoming electronics/sensors and load and functional earth			
Power supply, connection type	Plug			
Power supply, number of pins/cores	5		4	5
Power supply, conductor cross-section	1.5 mm ²	2.5 mm ²		

Technical data – Electrical – Additional supply for interlinking blocks

Power supply, connection technology	7/8" to NFPA/T3.5.29	M12x1, L-coded to EN 61076-2-111	M18x1	Push-pull to IEC 61076-3-126
Nominal operating voltage DC for electronics/sensors	24 V			
Nominal operating voltage DC load	24 V			
Note on the operating voltage	SELV/PELV power supply units required; note voltage drop			
Note on nominal operating voltage DC	24 V [XD-AR,PL], protected extra-low voltage to IEC 60204-1	24 V [XD-AL,PL], 24 V [XD-AR,PL], protected extra-low voltage to IEC 60204-1	24 V [XD-AR,PL], protected extra-low voltage to IEC 60204-1	24 V [XD-AL,PL], 24 V [XD-AR,PL], protected extra-low voltage to IEC 60204-1
Nominal current	8 A	10 A	8 A	10 A
Max. power supply	8 A (external fuse required)	10 A (external fuse required)	8 A (external fuse required)	10 A (external fuse required)
Electrical isolation between the supply voltages for electronics/sensors and load/valves	Yes		No	
Protection class	III			
Overvoltage category	II			

Datasheet – Interlinking block with additional supply

Technical data – Mechanical – Additional supply for interlinking blocks

Power supply, connection technology	7/8" to NFPA/T3.5.29	M12x1, L-coded to EN 61076-2-111	M18x1	Push-pull to IEC 61076-3-126
Type of mounting	On DIN rail with accessories; with through-hole for M5 screw with accessories; with through-hole for screw M6 with accessories			
Product weight	110 g	174 g	108 g	177 g
Dimensions W x L x H	(Installation dimensions); 50.1 mm x 122 mm x 35 mm	(Installation dimensions); 50.1 mm x 150 mm x 45.6 mm	(Installation dimensions); 50.1 mm x 124 mm x 35 mm	(Installation dimensions); 50.1 mm x 153 mm x 45.6 mm
Grid dimension	50.1 mm			

Materials – Additional supply for interlinking blocks

Power supply, connection technology	7/8" to NFPA/T3.5.29	M12x1, L-coded to EN 61076-2-111	M18x1	Push-pull to IEC 61076-3-126
Housing material	Reinforced PA			
Sealing material	Polyurethane foam			
Threaded seal material	TPE-U(PU)	–		
Flange material	–	Nickel-plated die-cast zinc	–	Nickel-plated die-cast zinc
Screw material	Nickel-plated steel			
Note on materials	RoHS-compliant; free of halogen; free of phosphoric acid ester			
LABS (PWIS) conformity	VDMA24364-B2-L			

Operating and environmental conditions – Additional supply for interlinking blocks

Ambient temperature	-20 ... 50 °C
Note on ambient temperature	Note ambient temperature derating to IEC 61131-2:2017
Storage temperature	-20 ... 70 °C
Corrosion resistance class CRC ¹⁾	1 - low corrosion stress
Relative humidity	5 - 95%, non-condensing
Nominal operating altitude	<= 2000 m ASL (> 79.5 kPa)
Max. setup altitude	3500 m
Note on max. setup altitude	> 2000 m ASL (< 79.5 kPa) Note ambient temperature derating to IEC 61131-2:2017
Vibration resistant	Transport application test with severity level 2 to FN 942017-4 and EN 60068-2-6
Note on vibration resistance	SG1 on DIN rail SG2 on direct mounting Transport application test with severity level 1 to FN 942017-4 and EN 60068-2-6
Shock resistance	Shock test with severity level 2 to FN 942017-5 and EN 60068-2-27
Note on shock resistance	30 g/11 ms to EN 60068-2-27 SG1 on DIN rail SG2 on direct mounting Shock test with severity level 1 to FN 942017-5 and EN 60068-2-27
Material fire test	UL94 V-0 (housing)

1) More information www.festo.com/x/topic/crc

Datasheet – Interlinking block with additional supply

Pin assignment, additional supply M18x1, 4-pin

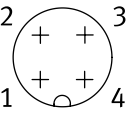
Terminal assignment	Pin	Assignment	Description
	1	n.c.	Not connected
	2	24 V	Operating voltage 24 V load voltage supply
	3	0 V	Operating voltage 0 V load voltage supply
	4	FE	Functional earth

Pin assignment, additional supply M12x1, L-coded, 5-pin

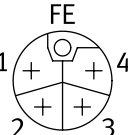
Terminal assignment	Pin	Assignment	Description
	1	n.c.	Not connected
	2	0 V	Operating voltage 0 V load voltage supply
	3	n.c.	Not connected
	4	24 V	Operating voltage 24 V load voltage supply
	FE	FE	Functional earth



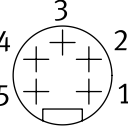

Pin assignment, additional supply 7/8" to NFPA/T3.5.29, 5-pin

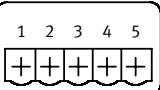







Terminal assignment	Pin	Assignment	Description
	1	0 V	Operating voltage 0 V load voltage supply
	2	n.c.	Not connected
	3	FE	Functional earth
	4	n.c.	Not connected
	5	24 V	Operating voltage 24 V load voltage supply

Pin assignment, additional supply push-pull to IEC 61076-3-126, 5-pin

Terminal assignment	Pin	Assignment	Description
	1	n.c.	Not connected
	2	n.c.	Not connected
	3	24 V	Operating voltage 24 V load voltage supply
	4	0 V	Operating voltage 0 V load voltage supply
	5	FE	Functional earth

Datasheet – Interlinking block with additional supply

Ordering data				
	Power supply, connection technology	Note on nominal operating voltage DC	Part no.	Type
	M12x1, L-coded to EN 61076-2-111	24 V [XD-AR,PL]	8129260	CPX-AP-A-AR-1-M12-5P
		24 V [XD-AL,PL]	8129263	CPX-AP-A-AL-1-M12-5P
	M18x1	24 V [XD-AR,PL]	8129258	CPX-AP-A-AR-1-M18-4P
	7/8" to NFPA/T3.5.29	24 V [XD-AR,PL]	8129259	CPX-AP-A-AR-1-7/8-5P
	Push-pull to IEC 61076-3-126	24 V [XD-AR,PL]	8129257	CPX-AP-A-AR-1-PP-5P
		24 V [XD-AL,PL]	8129262	CPX-AP-A-AL-1-PP-5P

Ordering data – Accessories					
	Description	Cable fitting	Permissible cable diameter	Part no.	Type
Plug connectors for self-assembly					
	Straight socket, M12x1, L-coded to EN 61076-2-111, 5-pin	–	8 - 13 mm for electrical connection 1	8166793	NECL-L12G5-C2-Q10
	Angled socket, M12x1, L-coded to EN 61076-2-111, 5-pin	–	8 - 13 mm for electrical connection 1	8166794	NECL-L12W5-C2-Q10
	Straight socket, 4-pin	Pg9	6 - 8 mm	18493	NTSD-GD-9
		Pg13	10 - 12 mm	18526	NTSD-GD-13.5
	Angled socket, 4-pin	Pg9	6 - 8 mm	18527	NTSD-WD-9
		Pg11	5 - 11 mm	533119	NTSD-WD-11
	Straight socket, 7/8", 5-pin	–	6 - 12 mm	543107	NECU-G78G5-C2
	Straight socket, plug pattern PP, coding on pin 2 and 5	Pg13.5, hex, AF22	9 - 13 mm	5195383	NECU-M-PPG5PP-C1-PN
Cable seal					
	For push-pull to IEC 61076-3-126	For adapting to cable diameter 6.5 ... 9.5 mm		8079860	NEAU-KD-P4-A1-P5
Mounting					
	For wall mounting			8130844	CAFM-X5-A

Datasheet – Interlinking block with forwarding supply

Function

Interlinking blocks ensure the electrical supply of all other CPX-AP-A modules. They have contact rails, from which the other CPX components on the interlinking modules are supplied with power.

The internal division of the power supply allows specific areas of the sensors and actuators to be switched off individually.

Application area

- All voltages are fed through to the next module via the interlinking blocks with forwarding supply.
- The interlinking blocks with forwarding supply make all voltages available to an external consumer.
- 24 V DC supply voltage for valves
- 24 V DC supply voltage for outputs

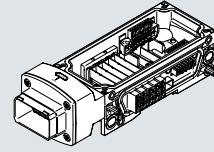

General technical data – Forwarding supply for interlinking blocks

Mounting position	Any, on DIN rail: horizontal
-------------------	------------------------------

Technical data – Interfaces – Forwarding supply for interlinking blocks

Power transmission, function	Outgoing electronics/sensors and load and functional earth
Power transmission, connection type	Plug
Power transmission, connection technology	Push-pull to IEC 61076-3-126
Power transmission, number of pins/cores	5

Technical data – Electrical – Forwarding supply for interlinking blocks

Nominal operating voltage DC for electronics/sensors	24 V
Nominal operating voltage DC load	24 V
Note on the operating voltage	SELV/PELV power supply units required; note voltage drop
Note on nominal operating voltage DC	2x24 V [XD2,PS,PL], protected extra-low voltage to IEC 60204-1
Nominal current	10 A
Max. power supply	2 x 10 A (external fuse required)
Electrical isolation between the supply voltages for electronics/sensors and load/valves	Yes
Protection class	III
Overvoltage category	II

Technical data – Mechanical – Forwarding supply for interlinking blocks

Type of mounting	On DIN rail with accessories; with through-hole for M5 screw with accessories; with through-hole for screw M6 with accessories
Product weight	182 g
Dimensions W x L x H	(Installation dimensions); 50.1 mm x 153 mm x 45.6 mm
Grid dimension	50.1 mm

Materials – Forwarding supply for interlinking blocks

Housing material	Reinforced PA
Sealing material	Polyurethane foam
Flange material	Nickel-plated die-cast zinc
Screw material	Nickel-plated steel
Note on materials	RoHS-compliant; free of halogen; free of phosphoric acid ester
LABS (PWIS) conformity	VDMA24364-B2-L

Datasheet – Interlinking block with forwarding supply

Operating and environmental conditions – Forwarding supply for interlinking blocks	
Ambient temperature	-20 ... 50 °C
Note on ambient temperature	Note ambient temperature derating to IEC 61131-2:2017
Storage temperature	-20 ... 70 °C
Corrosion resistance class CRC ¹⁾	1 - low corrosion stress
Relative humidity	5 - 95%, non-condensing
Nominal operating altitude	<= 2000 m ASL (> 79.5 kPa)
Max. setup altitude	3500 m
Note on max. setup altitude	> 2000 m ASL (< 79.5 kPa) Note ambient temperature derating to IEC 61131-2:2017
Vibration resistant	Transport application test with severity level 2 to FN 942017-4 and EN 60068-2-6
Note on vibration resistance	SG1 on DIN rail SG2 on direct mounting Transport application test with severity level 1 to FN 942017-4 and EN 60068-2-6
Shock resistance	Shock test with severity level 2 to FN 942017-5 and EN 60068-2-27
Note on shock resistance	30 g/11 ms to EN 60068-2-27 SG1 on DIN rail SG2 on direct mounting Shock test with severity level 1 to FN 942017-5 and EN 60068-2-27
Material fire test	UL94 V-0 (housing)

1) More information www.festo.com/x/topic/crc

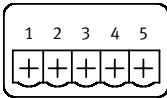
Pin assignment, forwarding supply			
Terminal assignment	Pin	Assignment	Description
	1	24 V	Operating voltage 24 V electronics and sensors
	2	0 V	Operating voltage 0 V electronics and sensors
	3	24 V	Operating voltage 24 V load voltage supply
	4	0 V	Operating voltage 0 V load voltage supply
	5	FE	Functional earth

Ordering data				
	Power transmission, function	Power transmission, connection technology	Part no.	Type
	Outgoing electronics/sensors and load and functional earth	Push-pull to IEC 61076-3-126	8169617	CPX-AP-A-W-1-PP-5P

Ordering data – Accessories					
	Description	Cable fitting	Permissible cable diameter	Part no.	Type

Plug connectors for self-assembly					
	Straight socket, plug pattern PP, coding on pin 2 and 5	Pg13.5, hex, AF22	9 - 13 mm	5195383	NECU-M-PPG5PP-C1-PN

Cable seal					
	For push-pull to IEC 61076-3-126	For adapting to cable diameter 6.5 ... 9.5 mm		8079860	NEAU-KD-P4-A1-P5

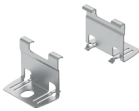
Mounting					
	For wall mounting			8130844	CAFM-X5-A

Datasheet – Interlinking module

Function

Interlinking blocks ensure the electrical supply of all other CPX-AP-A modules. They have contact rails, from which the other CPX components on the interlinking modules are supplied with power.

The internal division of the power supply allows specific areas of the sensors and actuators to be switched off individually.

Application area

- All voltages are fed through to the next module via the interlinking blocks without supply.
- The connected electronics module for inputs/outputs or bus node taps off the required voltage.

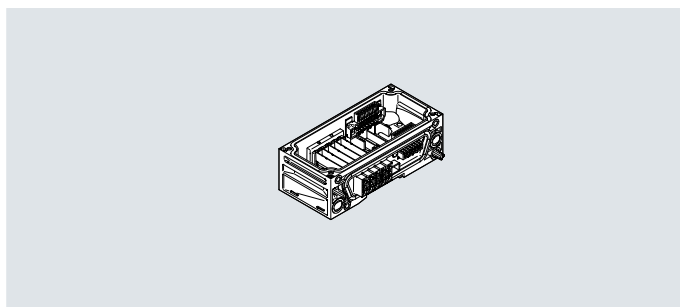

General technical data – Interlinking module for interlinking blocks

Mounting position	Any, on DIN rail: horizontal
-------------------	------------------------------

Technical data – Electrical – Interlinking module for interlinking blocks

Nominal operating voltage DC for electronics/sensors	24 V
Nominal operating voltage DC load	24 V
Note on nominal operating voltage DC	Protected extra-low voltage to IEC 60204-1
Protection class	III
Overvoltage category	II

Technical data – Mechanical – Forwarding supply for interlinking blocks

Type of mounting	On DIN rail with accessories; with through-hole for M5 screw with accessories; with through-hole for screw M6 with accessories
Dimensions W x L x H	(Installation dimensions); 50.1 mm x 107.3 mm x 35 mm
Grid dimension	50.1 mm

Materials – Forwarding supply for interlinking blocks

Housing material	Reinforced PA
Sealing material	Polyurethane foam
Screw material	Nickel-plated steel
Note on materials	RoHS-compliant; free of halogen; free of phosphoric acid ester
LABS (PWIS) conformity	VDMA24364-B2-L

Datasheet – Interlinking module

Operating and environmental conditions – Interlinking module for interlinking blocks

Ambient temperature	-20 ... 50 °C
Note on ambient temperature	Note ambient temperature derating to IEC 61131-2:2017
Storage temperature	-20 ... 70 °C
Corrosion resistance class CRC ¹⁾	1 - low corrosion stress
Relative humidity	5 - 95%, non-condensing
Nominal operating altitude	<= 2000 m ASL (> 79.5 kPa)
Max. setup altitude	3500 m
Note on max. setup altitude	> 2000 m ASL (< 79.5 kPa) Note ambient temperature derating to IEC 61131-2:2017
Vibration resistant	Transport application test with severity level 2 to FN 942017-4 and EN 60068-2-6
Note on vibration resistance	SG1 on DIN rail SG2 on direct mounting Transport application test with severity level 1 to FN 942017-4 and EN 60068-2-6
Shock resistance	Shock test with severity level 2 to FN 942017-5 and EN 60068-2-27
Note on shock resistance	30 g/11 ms to EN 60068-2-27 SG1 on DIN rail SG2 on direct mounting Shock test with severity level 1 to FN 942017-5 and EN 60068-2-27
Material fire test	UL94 V-0 (housing)

1) More information www.festo.com/x/topic/crc

Ordering data

	Function	Product weight	Part no.	Type
	Interlinking module	–	8129251	CPX-AP-A-SB
	Additional functional safety for MPA valve terminals	99 g	8145696	CPX-AP-A-SB-F

Ordering data – Accessories

	Description	Part no.	Type
	For wall mounting	8130844	CAFM-X5-A

Datasheet – Pneumatic interface for valve terminals VTUX

Function

With the pneumatic interface for VTUX, a valve terminal VTUX can be operated as part of the remote I/O system CPX-AP-A.

- Indication of power supply and module diagnostics via LED indicators
- Up to 120 solenoid coils
- Short circuit switch-off, short circuit diagnostics and switching cycle counter

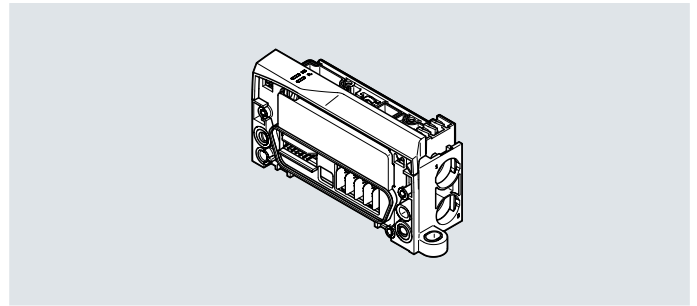

General technical data – Pneumatic interface for VTUX

Compatible with	Valve terminal VTUX-A-P	Valve terminal VTUX-A-S
Size	1 2	
Valve terminal design	Valve sizes can be mixed	
Protocol	AP	
Electrical control	AP interface	
Communication interface, protocol	AP	
Max. address volume for outputs	4 bytes	–
Max. no. of solenoid coils	32	120
Module parameters	Configuration of voltage monitoring load supply PL; behaviour in error state	
Diagnostics via LED	Diagnostics per module; power supply load	Diagnostics per module
Diagnostics via internal communication	Switch-off load supply; overvoltage electronics/sensors; undervoltage electronics/sensors	Undervoltage load supply PL; undervoltage logic supply PS
Undervoltage load/valves (diagnostic message)	≤21.1 V	
Reverse polarity protection	Yes	

Technical data – Electrical – Pneumatic interface for VTUX

Nominal operating voltage DC for electronics/sensors	24 V
Nominal operating voltage DC load	24 V
Permissible voltage fluctuations, electronics/sensors	± 25%
Permissible voltage fluctuations, load	± 10%
Note on the operating voltage	SELV/PELV power supply units required; note voltage drop
Power failure buffering	10 ms
Intrinsic current consumption at nominal operating voltage, electronics/sensors	Typical 27 mA
Intrinsic current consumption at nominal operating voltage, load	Typ. 13 mA
Power consumption at 24 VDC	650 mW
Power supply, function	Incoming electronics/sensors and load
Power transmission, function	Outgoing electronics/sensors and load
Electrical isolation between the supply voltages for electronics/sensors and load/valves	Yes
Electrical isolation of outputs between channel - internal communication	Yes
Protection (short circuit)	Internal electronic fuse per channel
Inductive protective circuit	Integrated
Overvoltage category	II
Protection against direct and indirect contact	PELV, SELV
Pollution degree	2

Datasheet – Pneumatic interface for valve terminals VTUX

Technical data – Mechanical – Pneumatic interface for VTUX

Compatible with	Valve terminal VTUX-A-P	Valve terminal VTUX-A-S
Type of mounting	With through-hole for M5 screw	
Type of mounting sub-base	With through-hole	
Product weight	126.7 g	120.7 g
Dimensions W x L x H	35.2 mm x 117.2 mm x 56.1 mm	
Max. tightening torque for wall mounting	6 Nm	
Connection position	On the side	
Pneumatic connection 1	For 15 mm cartridge	
Pneumatic port 5	For 15 mm cartridge	

Materials – Pneumatic interface for VTUX

Compatible with	Valve terminal VTUX-A-P	Valve terminal VTUX-A-S
Sub-base material	Reinforced PA	
Cover material	Reinforced PA	Reinforced PBT
Sealing material	NBR	
Clamp material	High-alloy stainless steel	
Sleeve material	High-alloy stainless steel	
Nut material	High-alloy stainless steel	
Note on materials	RoHS-compliant	
LABS (PWIS) conformity	VDMA24364-B1/B2-L	



Operating and environmental conditions – Pneumatic interface for VTUX

Compatible with	Valve terminal VTUX-A-P	Valve terminal VTUX-A-S
Ambient temperature	-20 ... 50 °C	-5 ... 50 °C
Storage temperature	-20 ... 70 °C	
Corrosion resistance class CRC ¹⁾	2 - Moderate corrosion stress	
Relative humidity	5 - 95%	
Nominal operating altitude	≤ 2000 m above sea level	
Max. setup altitude	3,500 m	
Vibration resistant	Transport application test with severity level 2 to FN 942017-4 and EN 60068-2-6	
Shock resistance	Shock test with severity level 2 to FN 942017-5 and EN 60068-2-27	
CE marking (see declaration of conformity) ²⁾	To EU EMC Directive, to EU-RoHS Directive	
UKCA marking (see declaration of conformity)	To UK EMC regulations; to UK RoHS regulations	
KC marking	KC EMC	
Certification	RCM Mark	
Degree of protection	IP65	

1) More information www.festo.com/x/topic/crc2) More information www.festo.com/catalogue/... Support/Downloads.

Datasheet – Pneumatic interface for valve terminals VTUX

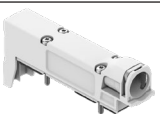
Ordering data				Part no.	Type
	Pneumatic interface for valve terminals VTUX	Compatible with valve terminal VTUX-A-P	Maximum 32 valve coils	8189594	VABX-A-P-EL-E12-APA-SHUH-XL
		Compatible with valve terminal VTUX-A-S	Maximum 120 valve coils	8189595	VABX-A-S-EL-E12-APA-SHUH-XL

Ordering data – Accessories					
Description				Part no.	Type
Plate					
	Position function 1-64: UD	Plate for ducted exhaust air, without cartridge, for mounting on pneumatic interface for valve terminals VTUX		8191794	VABF-XA-12-M2-QX
	Position function 1-64: US	Exhaust plate for mounting on manifold sub-base for pneumatic interface VTUX		8191741	VABF-XA-12-M1-C

Datasheet – Pneumatic interface for valve terminals VTSA

Function

With the pneumatic interface, a valve terminal VTSA can be operated as part of the remote I/O system CPX-AP-A.

- Indication of status and error messages via LED indicators
- Up to 32 valve positions with up to 32 solenoid coils
- Voltage supply and forwarding possible
- Short circuit switch-off, short circuit diagnostics and switching cycle counter

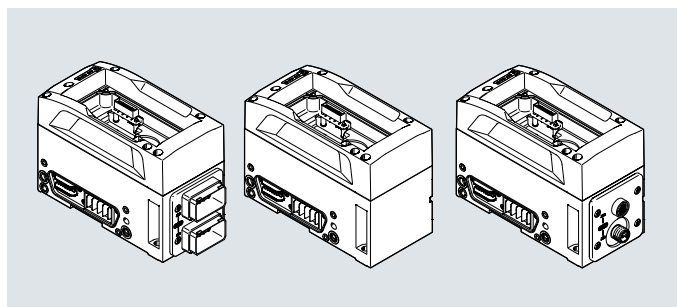

Implementation

Pneumatic interfaces for valve terminals VSTA, like an interlinking module, have a module slot for a CPX-AP-A module.

All CPX-AP-A modules can be mounted in this slot, e.g. bus interface and input/output modules.

The pneumatic connection includes mounting options for wall, DIN rail and carrier system mounting.

General technical data – Pneumatic interface for VTSA

Module code (hex/dec)	0x3040/12352d	0x3041/12353d	0x3042/12354d	0x3043/12355d	0x3044/12356d	0x3045/12357d
Electrical control	Fieldbus					
Communication interface, protocol	AP					
Valve terminal interface	Type 46, VTSA-F-CB				Type 44, VTSA, type 45, VTSA-F	
Max. number of valve positions	12 with double solenoid valves; 24 with single solenoid valves				16 with double solenoid valves; 32 with single solenoid valves	
Max. no. of solenoid coils	24				32	
Module parameters	Diagnostics activated via overload/short circuit; condition counter limit value/actual value; configuration of voltage monitoring of load supply PL; behaviour in error state					
Diagnostics via LED	Diagnostics per module; power supply load					
Diagnostics via internal communication	Switch-off load supply; communication error; short circuit/overload output signal; overvoltage electronics/sensors; overvoltage load; undervoltage electronics/sensors; undervoltage load					
Undervoltage load/valves (diagnostic message)	≤21.6 V					
Internal cycle time	< 1 ms					
Reverse polarity protection	Yes					

Technical data – Power supply interface – Pneumatic interface VTA

Module code (hex/dec)	0x3040/12352d	0x3041/12353d	0x3042/12354d	0x3043/12355d	0x3044/12356d	0x3045/12357d
Power supply, function	–	Incoming electronics/sensors and load and functional earth		–	Incoming electronics/sensors and load and functional earth	
Power supply, connection type	–	Plug		–	Plug	
Power supply, connection technology	–	M12x1, L-coded to EN 61076-2-111	Push-pull to IEC 61076-3-126	–	Push-pull to IEC 61076-3-126	
Power supply, number of pins/cores	–	5		–	5	
Power transmission, function	–	Outgoing electronics/sensors and load and functional earth		–	Outgoing electronics/sensors and load and functional earth	
Power transmission, connection type	–	Socket		–	Socket	
Power transmission, connection technology	–	M12x1, L-coded to EN 61076-2-111	Push-pull to IEC 61076-3-126	–	Push-pull to IEC 61076-3-126	
Power transmission, number of pins/cores	–	5		–	5	
Nominal current	–	16 A		–	16 A	

Datasheet – Pneumatic interface for valve terminals VTSA

Technical data – Electrical – Pneumatic interface VTSA						
Module code (hex/dec)	0x3040/12352d	0x3041/12353d	0x3042/12354d	0x3043/12355d	0x3044/12356d	0x3045/12357d
Nominal operating voltage DC for electronics/sensors	24 V					
Nominal operating voltage DC load	24 V					
Permissible voltage fluctuations, electronics/sensors	± 25%					
Permissible voltage fluctuations, load	± 10%					
Note on the operating voltage	SELV/PELV power supply units required; note voltage drop					
Power failure buffering	10 ms					
Max. power supply	–	2 x 16 A (external fuse required)		–	2 x 16 A (external fuse required)	
Intrinsic current consumption at nominal operating voltage, electronics/sensors	Typical 42 mA			Typical 40 mA	Typical 27 mA	
Intrinsic current consumption at nominal operating voltage, load	Typical 15 mA			Typical 17 mA		
Electrical isolation between the supply voltages for electronics/sensors and load/valves	Yes					
Electrical isolation between channel and internal bus	–			Yes, when using an additional supply for the valves	–	
Protection (short circuit)	Internal electronic fuse protection per valve output					
Protection class	III					
Overvoltage category	II					
Pollution degree	2					

Technical data – Mechanical – Pneumatic interface VTSA						
Module code (hex/dec)	0x3040/12352d	0x3041/12353d	0x3042/12354d	0x3043/12355d	0x3044/12356d	0x3045/12357d
Type of mounting	With through-hole for M6 screw					
Product weight	1,246 g	1,306 g	1,325 g	1,238 g	1,245 g	1,328 g
Dimensions W x L x H	70.5 mm x 142 mm x 102.6 mm	70.5 mm x 154.4 mm x 102.6 mm	70.5 mm x 160.65 mm x 102.6 mm	70.5 mm x 142 mm x 102.6 mm		70.5 mm x 160.65 mm x 102.6 mm

Materials – Pneumatic interface VTSA						
Module code (hex/dec)	0x3040/12352d	0x3041/12353d	0x3042/12354d	0x3043/12355d	0x3044/12356d	0x3045/12357d
Housing material	Aluminium					
Cover material	Powder-coated die-cast zinc					
O-ring material	–	FPM	–			
Sealing material	NBR, PUR					
Flange material	–	Nickel-plated die-cast zinc		–	Nickel-plated die-cast zinc	
Screw material	Nickel-plated steel					
Note on materials	RoHS-compliant; free of halogen; free of phosphoric acid ester					
LABS (PWIS) conformity	VDMA24364-B2-L					

Datasheet – Pneumatic interface for valve terminals VTSA

Operating and environmental conditions – Pneumatic interface for VTSA

Ambient temperature	-20 ... 50 °C
Note on ambient temperature	Note ambient temperature derating to IEC 61131-2:2017
Storage temperature	-20 ... 70 °C
Corrosion resistance class CRC ¹⁾	0 - no corrosion stress
Relative humidity	5 - 95%, non-condensing
Nominal operating altitude	<= 2000 m ASL (> 79.5 kPa)
Max. setup altitude	3,500 m
Note on max. setup altitude	> 2000 m ASL (< 79.5 kPa) Note ambient temperature derating to IEC 61131-2:2017
Vibration resistant	Transport application test with severity level 2 to FN 942017-4 and EN 60068-2-6
Note on vibration resistance	SG2 on wall mounting
Shock resistance	Shock test with severity level 2 to FN 942017-5 and EN 60068-2-27
Note on shock resistance	SG2 on wall mounting

1) More information www.festo.com/x/topic/crc

Pin assignment, system supply plug M12x1, L-coded, 5-pin

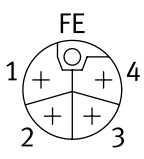
Terminal assignment	Pin	Assignment	Description
	1	24 V	Operating voltage 24 V electronics and sensors
	2	0 V	Operating voltage 0 V load voltage supply
	3	0 V	Operating voltage 0 V electronics and sensors
	4	24 V	Operating voltage 24 V load voltage supply
	FE	FE	Functional earth

Pin assignment, forwarding supply socket M12x1, L-coded, 5-pin

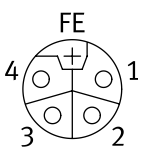
Terminal assignment	Pin	Assignment	Description
	1	24 V	Operating voltage 24 V electronics and sensors
	2	0 V	Operating voltage 0 V load voltage supply
	3	0 V	Operating voltage 0 V electronics and sensors
	4	24 V	Operating voltage 24 V load voltage supply
	FE	FE	Functional earth

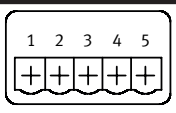

Pin assignment, system supply push-pull to IEC 61076-3-126, 5-pin

Terminal assignment	Pin	Assignment	Description
	1	24 V	Operating voltage 24 V electronics and sensors
	2	0 V	Operating voltage 0 V electronics and sensors
	3	24 V	Operating voltage 24 V load voltage supply
	4	0 V	Operating voltage 0 V load voltage supply
	5	FE	Functional earth

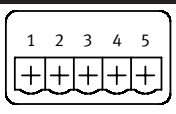



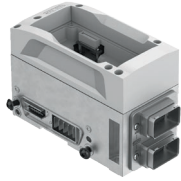

Pin assignment, forwarding supply

Terminal assignment	Pin	Assignment	Description
	1	24 V	Operating voltage 24 V electronics and sensors
	2	0 V	Operating voltage 0 V electronics and sensors
	3	24 V	Operating voltage 24 V load voltage supply
	4	0 V	Operating voltage 0 V load voltage supply
	5	FE	Functional earth

Datasheet – Pneumatic interface for valve terminals VTSA

Ordering data						
	Power supply, function	Power supply, connection technology	Valve terminal interface	Module code (hex/dec)	Part no.	Type
	–	–	Type 44, VTSA, type 45, VTSA-F	0x3044/12356d	8154036	VABA-S6-1-X5
			Type 46, VTSA-F-CB	0x3040/12352d	8154037	VABA-S6-1-X5-CB
				0x3043/12355d	8154041	VABA-S6-1-X5-F5-CB
	Incoming electronics/sensors and load and functional earth	Push-pull to IEC 61076-3-126	Type 44, VTSA, type 45, VTSA-F	0x3045/12357d	8154039	VABA-S6-1-X5-F4
			Type 46, VTSA-F-CB	0x3042/12354d	8154040	VABA-S6-1-X5-F4-CB
		M12x1, L-coded to EN 61076-2-111	Type 46, VTSA-F-CB	0x3041/12353d	8154038	VABA-S6-1-X5-F3-CB

Ordering data – Accessories

	Description	Cable fitting	Permissible cable diameter	Part no.	Type
Plug connectors for self-assembly					
	Straight socket, M12x1, L-coded to EN 61076-2-111, 5-pin	–	8 - 13 mm for electrical connection 1	8166793	NECL-L12G5-C2-Q10
	Angled socket, M12x1, L-coded to EN 61076-2-111, 5-pin	–	8 - 13 mm for electrical connection 1	8166794	NECL-L12W5-C2-Q10
	Straight plug, M12x1, L-coded to EN 61076-2-111, 5-pin	–	8 - 13 mm for electrical connection 1	8166791	NECL-S-L12G5-C2-Q10
	Angled plug, M12x1, L-coded to EN 61076-2-111, 5-pin	–	8 - 13 mm for electrical connection 1	8166792	NECL-S-L12W5-C2-Q10
	Straight socket, plug pattern PP, coding on pin 2 and 5	Pg13.5, hex, AF22	9 - 13 mm	5195383	NECU-M-PPG5PP-C1-PN
Cable seal					
	For push-pull to IEC 61076-3-126	For adapting to cable diameter 6.5 ... 9.5 mm		8079860	NEAU-KD-P4-A1-P5

Datasheet – Pneumatic interface for valve terminals MPA-S

Function

With the pneumatic interface for MPA-S, a valve terminal MPA-S can be operated as part of the remote I/O system CPX-AP-A.

- Indication of power supply and module diagnostics via LED indicators

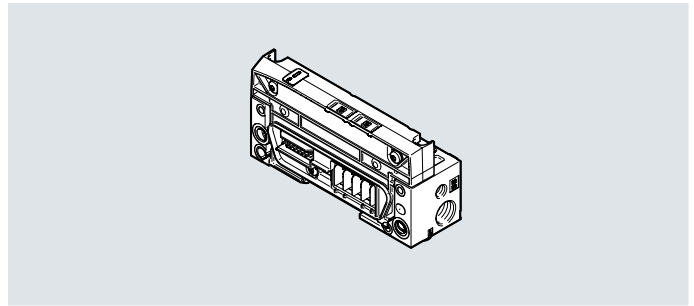
**General technical data – Pneumatic interface for MPA-S**

Module code (hex/dec)	0x3052/12370d, 0x3053/12371d
Electrical control	AP interface
Communication interface, protocol	AP
Diagnostics via LED	Diagnostics per module
Diagnostics via internal communication	Communication errors; overvoltage electronics/sensors; undervoltage electronics/sensors
Internal cycle time	1 ms
Reverse polarity protection	Yes
Note on reverse polarity protection	Self-protection
Mounting position	Any, on DIN rail: horizontal

Technical data – Electrical – Pneumatic interface MPA-S

Valve terminal interface	Type 32, MPA-FB-AP-VI
Nominal operating voltage DC for electronics/sensors	24 V
Nominal operating voltage DC load	24 V
Permissible voltage fluctuations, electronics/sensors	± 25%
Permissible voltage fluctuations, load	± 25%
Note on the operating voltage	SELV/PELV power supply units required; note voltage drop
Power failure buffering	10 ms
Intrinsic current consumption at nominal operating voltage, electronics/sensors	Typical 35 mA
Electrical isolation between the supply voltages for electronics/sensors and load/valves	Yes
Protection (short circuit)	Additional safety fuse
Protection class	III
Overvoltage category	II
Pollution degree	2

Technical data – Mechanical – Pneumatic interface MPA-S

Module code (hex/dec)	0x3052/12370d	0x3053/12371d
Type of mounting	With through-hole for M4 screw	
Product weight	207 g	
Dimensions W x L x H	34.1 mm x 107.3 mm x 55.1 mm	
Width	34.1 mm	
Length	107.3 mm	
Pneumatic connection 1	G1/4	
Pilot air port 12/14	M7	
Integrated function	Flat plate silencer, ducted exhaust air	
Pilot air supply	Internal	External

Datasheet – Pneumatic interface for valve terminals MPA-S

Materials – Pneumatic interface MPA-S

Housing material	Die-cast aluminium
Cover material	Reinforced PBT
Sealing material	Polyurethane foam
Screw material	Galvanised steel
Note on materials	RoHs-compliant
LABS (PWIS) conformity	VDMA24364-B2-L

Operating and environmental conditions – Pneumatic interface for MPA-S

Ambient temperature	-20 ... 50 °C
Note on ambient temperature	Note ambient temperature derating to IEC 61131-2:2017
Storage temperature	-20 ... 70 °C
Corrosion resistance class CRC ¹⁾	1 - low corrosion stress
Relative humidity	5 - 95%, non-condensing
Nominal operating altitude	<= 2000 m ASL (> 79.5 kPa)
Max. setup altitude	3,500 m
Note on max. setup altitude	> 2000 m ASL (< 79.5 kPa) Note ambient temperature derating to IEC 61131-2:2017
Vibration resistant	Transport application test with severity level 2 to FN 942017-4 and EN 60068-2-6
Note on vibration resistance	SG2 on wall mounting
Shock resistance	Shock test with severity level 2 to FN 942017-5 and EN 60068-2-27
Note on shock resistance	SG2 on wall mounting
Degree of protection	IP65; IP67
Note on degree of protection	In mounted state

1) More information www.festo.com/x/topic/crc

Ordering data

		Part no.	Type
	Pneumatic interface for valve terminals MPA-S	Internal pilot air supply	8137156 VMPA-AP-EPL-G
		External pilot air supply	8137154 VMPA-AP-EPL-E

Datasheet

Dimensions

Download CAD data → www.festo.com

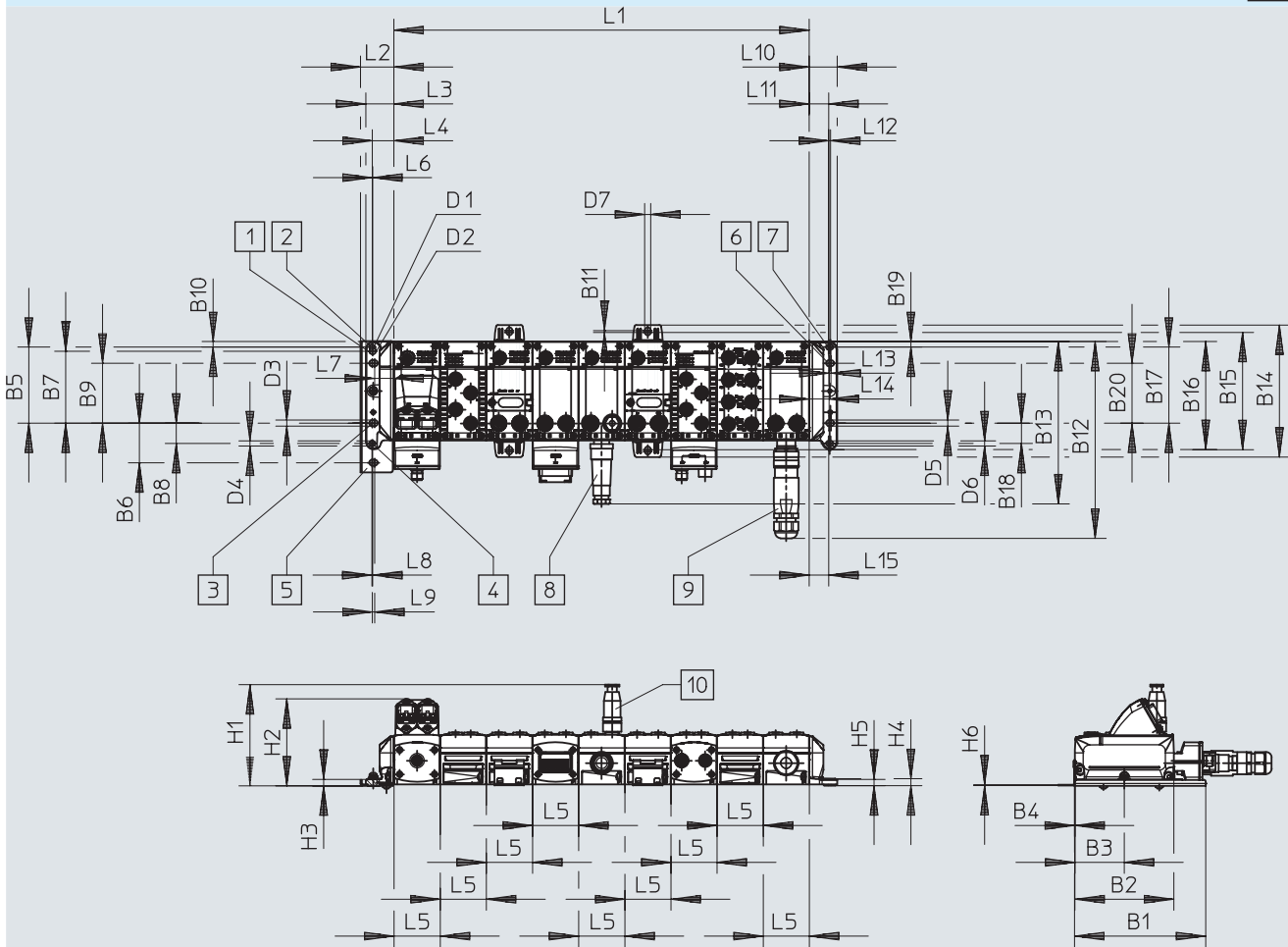

- [1] Mounting hole for M5 screws
- [2] Mounting hole for M6 screws
- [3] Mounting hole for M6 screw
- [4] Mounting hole for M5 screw
- [5] Mounting bracket for system assembly
- [6] Mounting hole for M6 screw
- [7] Mounting hole for M5 screw
- [8] Plug M18
- [9] Plug 7/8"
- [10] Plug M12x1

	B1	B2	B3	B4	B5	B6	B7	B8	B9	B10	B11	B12	B13	B14	B15	B16	B17	B18	B19	B20
CPX-AP-A	142.5	107.3	53.7	0.5	82.5	43.1	78	22.1	65	6	2	213.45	176.1	143.3	129.3	117.15	82.5	22.1	6	65

	D1	D2	D3	D4	D5	D6	D7	H1	H2	H3	H4	H5	H6
CPX-AP-A	5.7	6.7	6.7	5.7	6.7	5.7	6.6	109.6	94.2	7	7.6	6.8	0.8

	L1 ¹⁾	L2	L3	L4	L5	L6	L7	L8	L9	L10	L11	L12	L13	L14	L15
CPX-AP-A	nx 50.1	36.4	30.4	23.5	50.1	0.5	20.9	0.8	2.5	30.4	22.15	2	2	21.6	22.15

1) n = Number of interlinking blocks